

14ft Deluxe Universal Frame Pad Installation Instructions

Retain address information for future use.

JumpSport, Inc.
2055 South 7th Street, Suite A
San Jose, CA 95112 U.S.A.

408-213-2551
www.jumpsport.com

P/N: INS-P-10487G

Copyright Notice

This material is protected by United States copyright laws and is proprietary to JumpSport, Inc. Disclosure, reproduction, translation, modification, or use of this document by anyone other than authorized employees, authorized users, or licensees of JumpSport without the prior written consent of JumpSport, Inc. is prohibited.

The information in this document is subject to change without notice. JumpSport, Inc. shall not be liable for any damages resulting from technical errors or omissions, which may be present in this document, or from use of this document.

Copyright © 2003-2009, by JumpSport, Inc. All rights reserved.

Printed: 2009

Instruction Manual P/N: INS-P-10487G

AlleyOop 14ft Deluxe Universal Frame Pad P/N: PAD-S-11383A

Trademarks

JumpSport® and AlleyOop Sports® are trademarks of JumpSport, Inc.

All other brand or product names are trademarks or registered trademarks of their respective companies or organizations.

How to Contact Customer Support

Should you require customer service or technical support for your AlleyOop 14ft Deluxe Universal Frame Pad, please contact AlleyOop Sports' Customer Service department at:

408-213-2551

8:00am – 5:00pm Monday through Friday, Pacific Time



Assembly and Installation Instructions

Thank you for purchasing an AlleyOop 14ft Deluxe Universal Frame Pad!

The following pages contain diagrams, pictures, and written instructions for installing your 14ft Deluxe Universal Frame Pad.

Familiarize yourself with the Assembly and Installation Instructions before beginning installation.



Trampoline use is not recommended without the frame pad installed (see Picture A, below). The frame pad is designed to reduce the possibility of injury by protecting the user from coming into contact with the frame and springs of the trampoline. It is very important that you properly and securely attach the frame pad to the frame, and that it is in the correct position prior to using the trampoline.



Frame Pad Placement - Showing Correct Placement over Frame Rails and Springs
(Section of frame pad removed for clarity. Be sure pad is completely installed before use.)

Parts List

Your 14ft Deluxe Universal Frame Pad comes with a 8 frame pad sections, 16 Velcro pad connectors, 8 pad bungees, and 8 button T-anchors (button T-anchors are not used on all installations).

Assembly and Installation Instructions

Before you begin installing your Deluxe Universal Frame Pad, please find which type of safety enclosure pole installation you have below.

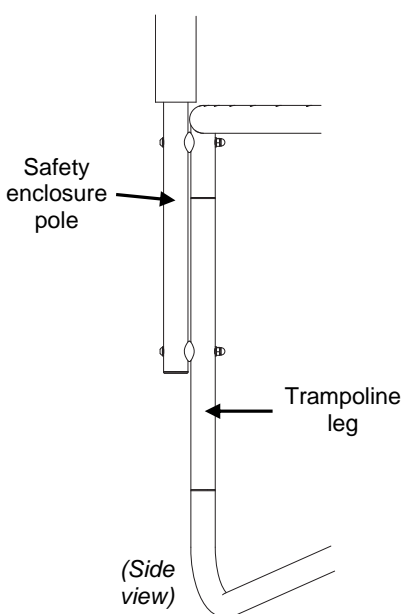
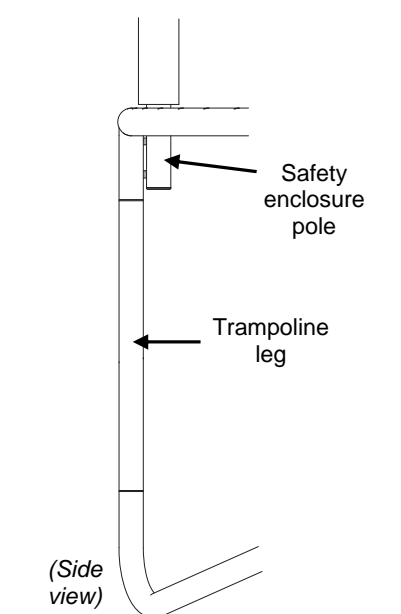
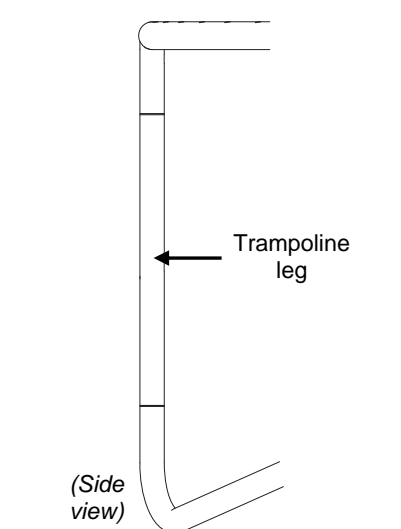
<p>Poles mounted on outside of trampoline legs</p>  <p>(Side view)</p> <p>Type A assembly instructions begin on page 5</p>	<p>Poles mounted on inside of trampoline legs</p>  <p>(Side view)</p> <p>Type B assembly instructions begin on page 8</p>	<p>Trampoline with no safety enclosure</p>  <p>(Side view)</p> <p>Type C assembly instructions begin on page 11</p>
---	--	--

Type A Assembly

Type A is for trampoline enclosure poles that are mounted on the *outside* of the trampoline legs.

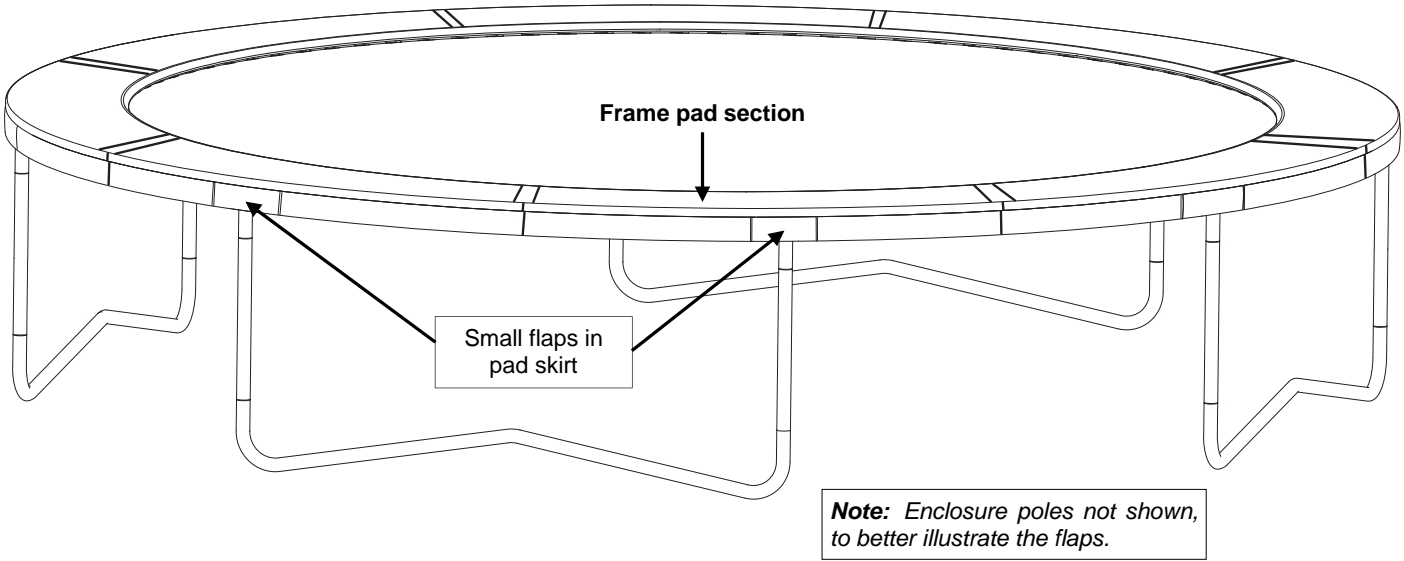

1) Lay the 8 frame pad sections on the trampoline to create a full circle around the trampoline frame. Metal grommets on each pad section should face the ground. Align pad so that small flaps on outside edge of pad skirt line up over each leg of trampoline.

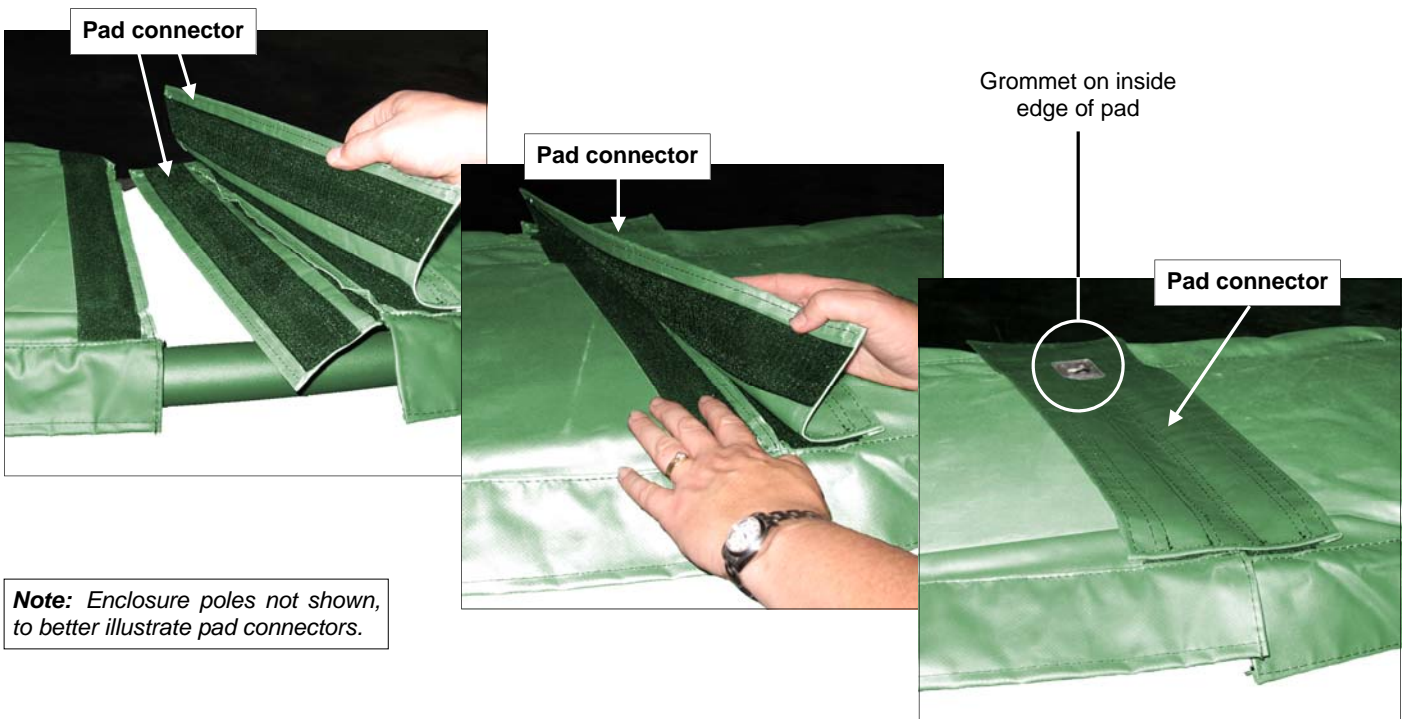

2) Two pad connectors are used to connect adjacent pad sections together; one pad connector connects to the top of each pad section and the second pad connector connects to the bottom of each pad section. Grommet on each pad connector must be on inside edge of pad (closest to jumping mat).

Assembly and Installation Instructions (Type A)

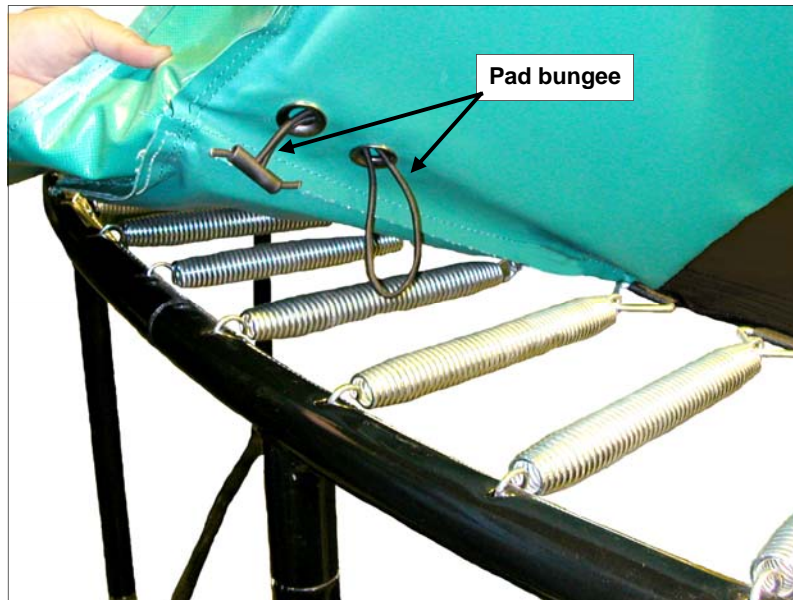

Note: Enclosure poles not shown, to better illustrate pad bungee location.

3) Install pad bungees through the 2 metal grommets near outside edge of pad, as shown. Grommets should be on bottom side of pad near each leg.

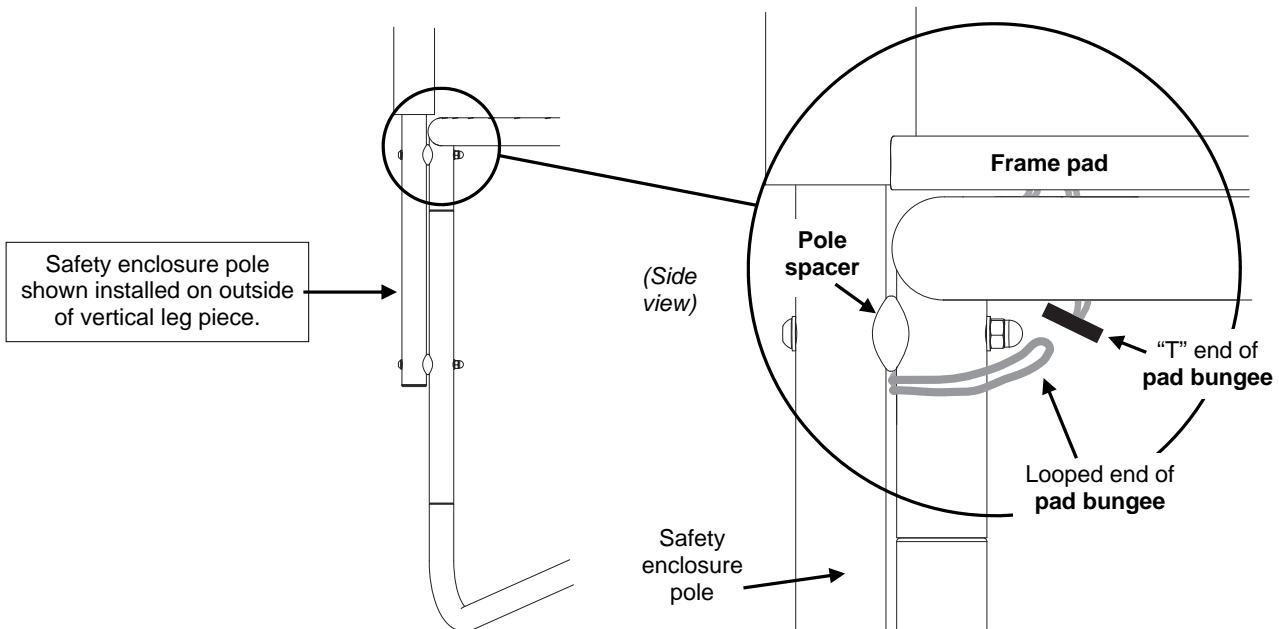

4) Wrap each pad bungee between the vertical leg piece and pole, just below top pole spacer, as shown. (If you do not have pole spacers, then wrap pad bungee around both pole and leg.) Then wrap looped end of pad bungee around the "T" on the opposite end of bungee.

Note: Be sure pad bungee can move freely after connecting around leg of trampoline.

Note: Bungee should NOT wrap around rail of trampoline. It should only wrap around the leg/pole.

Assembly and Installation Instructions (Type A)

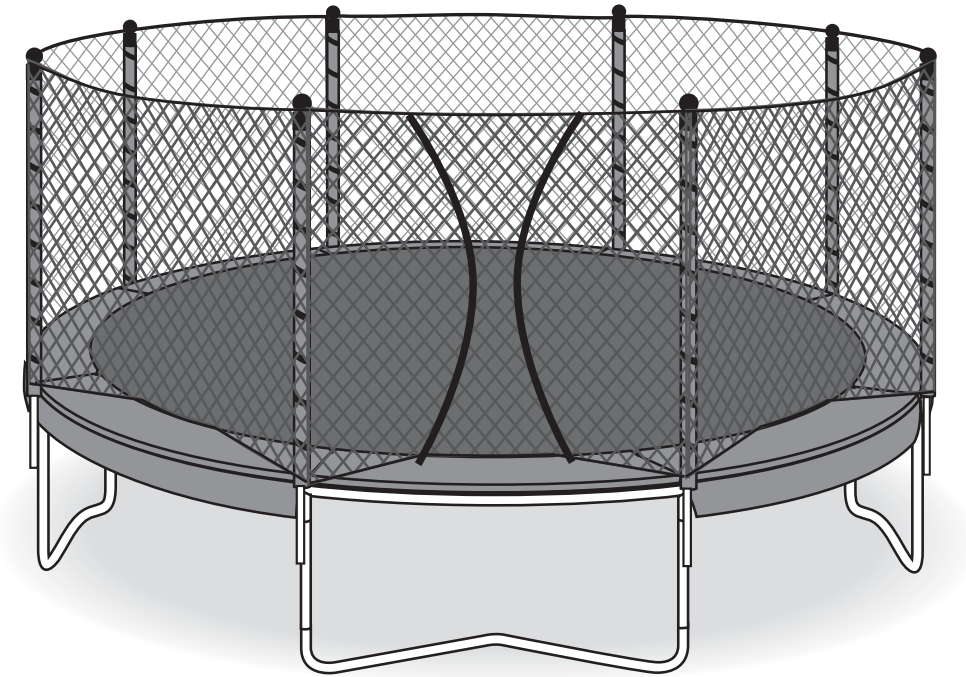

Your 14ft Deluxe Universal Frame Pad is now installed!

To remove the frame pad, follow the Installation Instructions in reverse order.

Assembly and Installation Instructions (Type B)

Type B Assembly

Type B is for trampoline enclosure poles that are mounted on the *inside* of the trampoline legs.

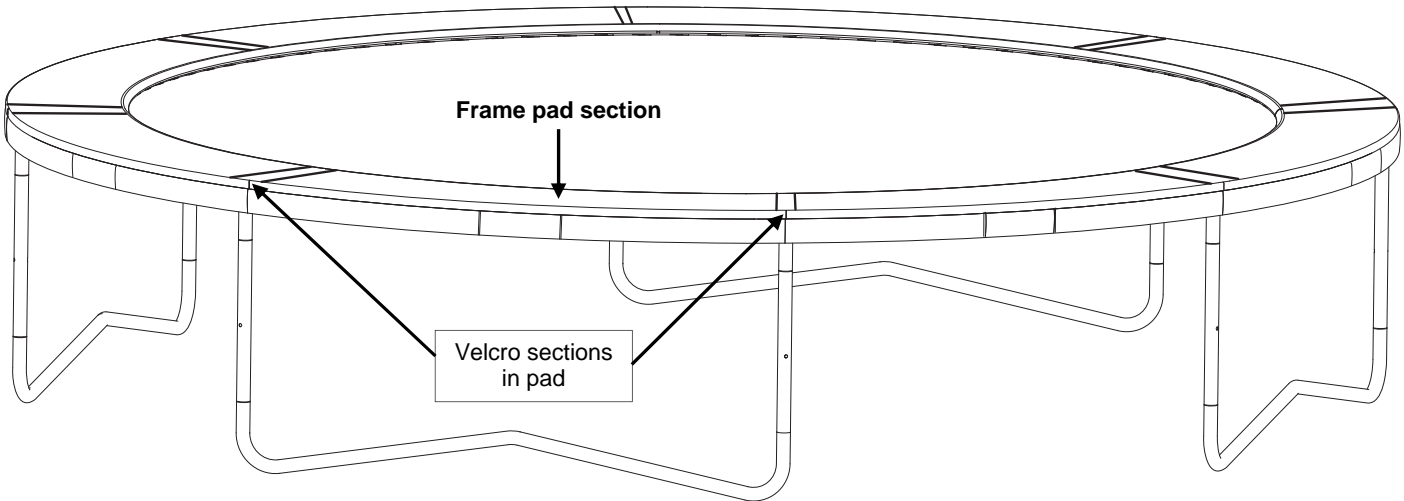

Note: Enclosure poles not shown, to better illustrate the Velcro sections.

1) Lay the 8 frame pad sections on the trampoline to create a full circle around the trampoline frame. Metal grommets on each pad section should face the ground. Align pad so that Velcro sections of each pad section line up over each leg of trampoline.

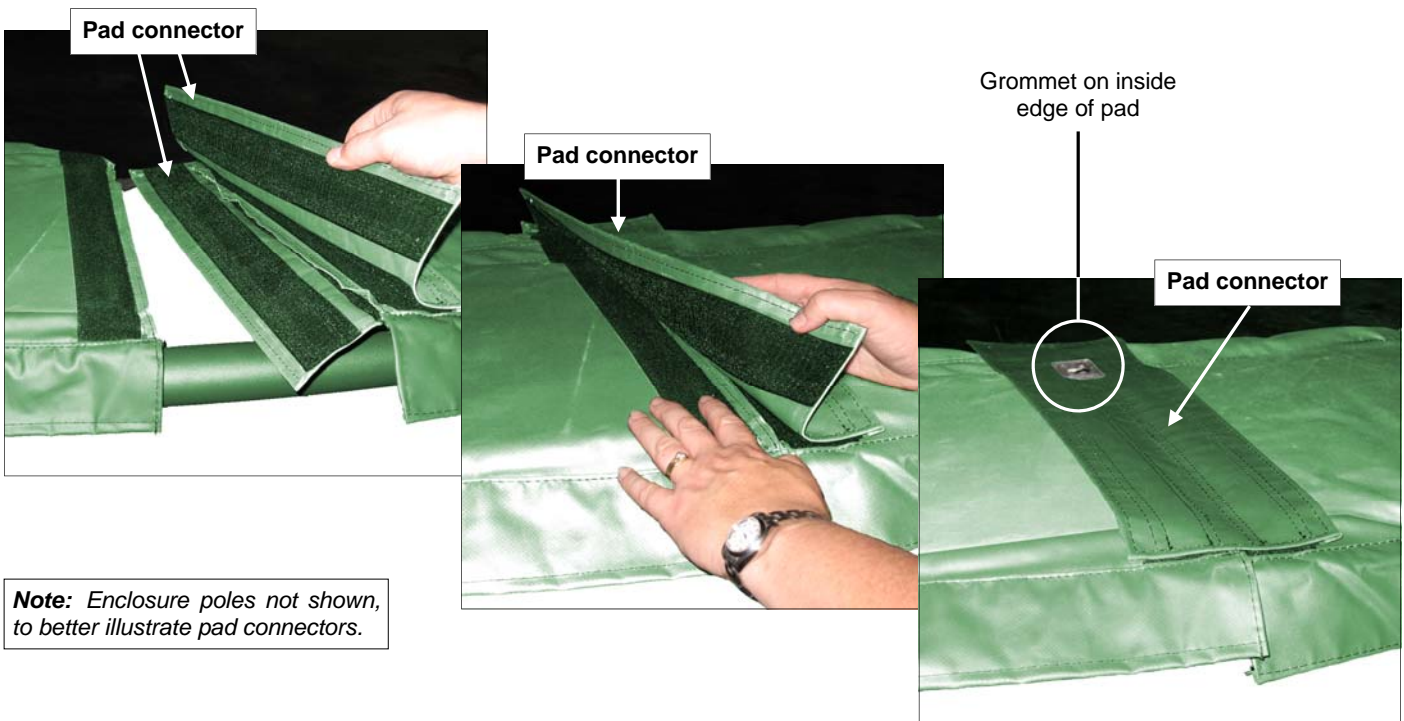

Note: Enclosure poles not shown, to better illustrate pad connectors.

2) Two pad connectors are used to connect adjacent pad sections together; one pad connector connects to the top of each pad section and the second pad connector connects to the bottom of each pad section. Grommet on each pad connector must be on inside edge of pad (closest to jumping mat).

Assembly and Installation Instructions (Type B)



3) Pad connector will fold at pole, as shown. Both top and bottom pad connectors will be folded.



Note: Enclosure poles not shown, to better illustrate pad bungee location.

4) Install pad bungees through the 2 metal grommets near outside edge of pad, as shown. Grommets should be on bottom side of pad between legs.

Assembly and Installation Instructions (Type B)

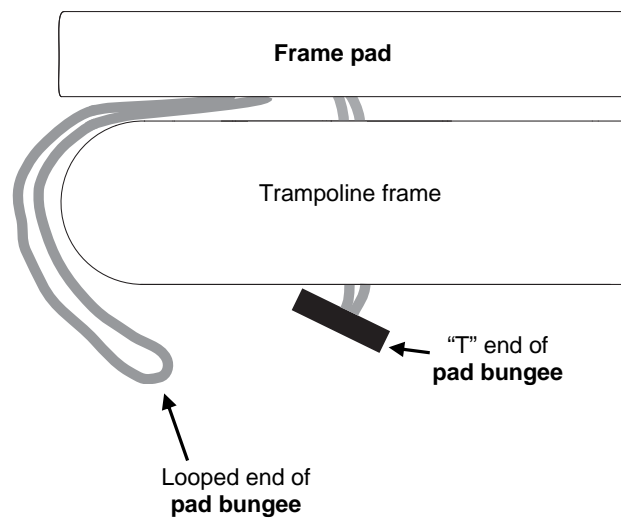

5) Wrap pad bungee around trampoline frame and secure looped end of pad bungee around the "T" on the opposite end of bungee.

Note: Be sure pad bungee can move freely after connecting around frame of trampoline.

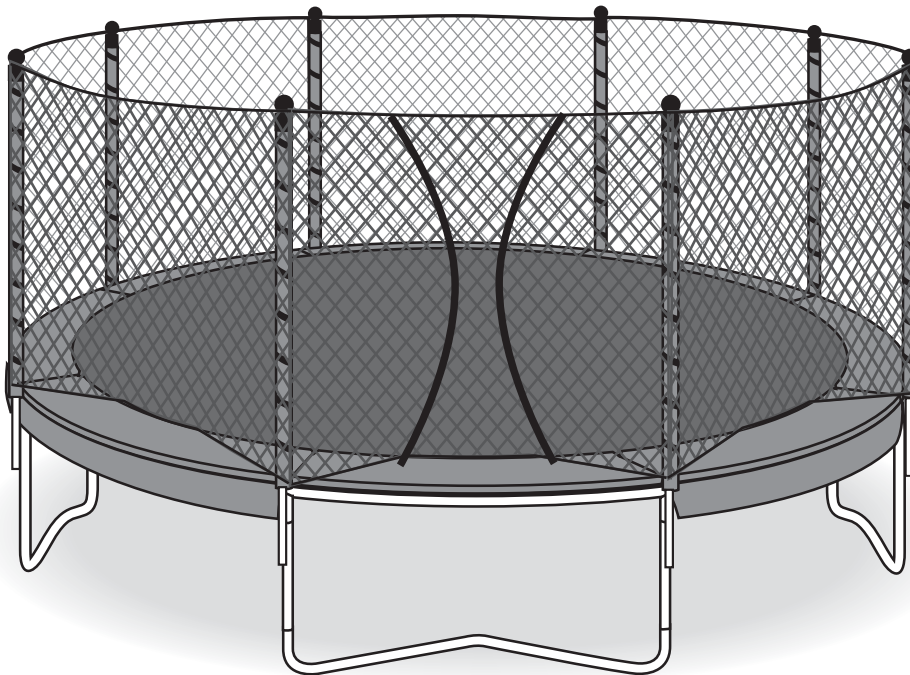

Your 14ft Deluxe Universal Frame Pad is now installed!

To remove the frame pad, follow the Installation Instructions in reverse order.

Type C Assembly

Type C is for trampolines that do not have a safety enclosure installed. (A safety enclosure is *always* recommended. See www.jumpsport.com for more details, or call our Customer Service Department at 408-213-2579.)

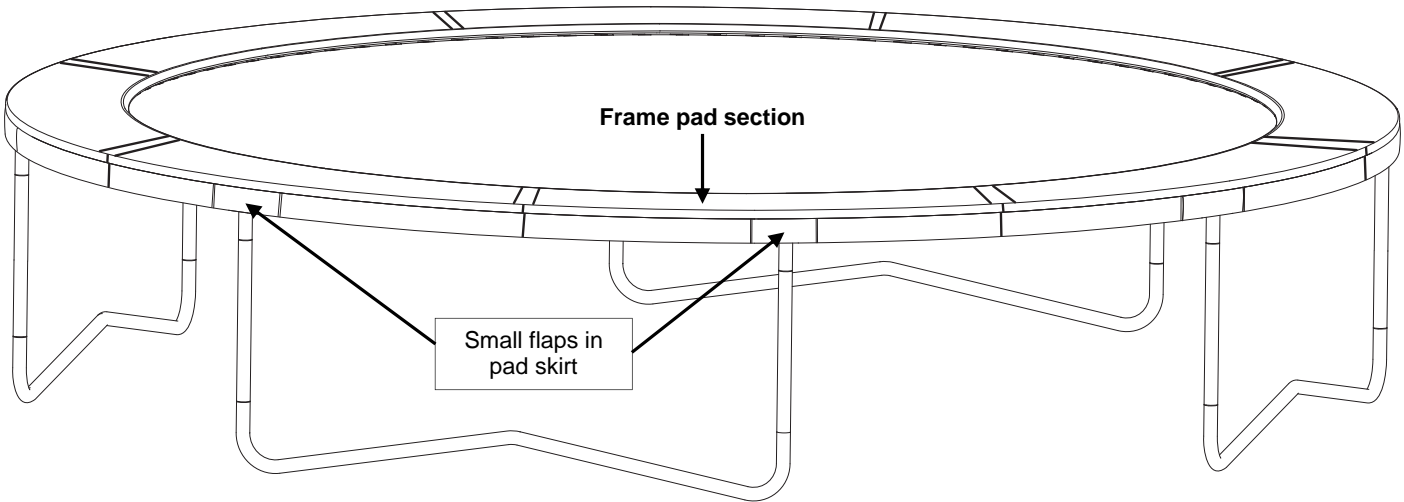

1) Lay the 8 frame pad sections on the trampoline to create a full circle around the trampoline frame. Metal grommets on each pad section should face the ground. Align pad so that small flaps on outside edge of pad skirt line up over each leg of trampoline.

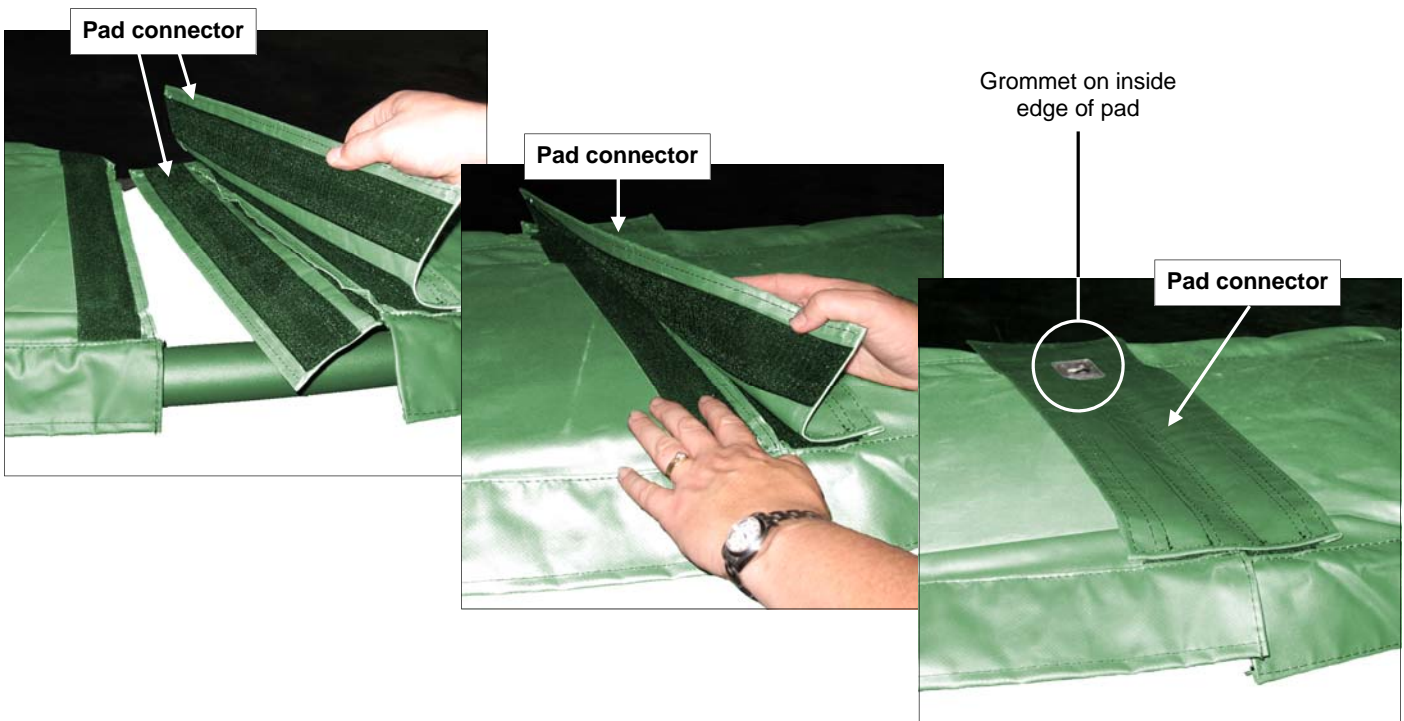

2) Two pad connectors are used to connect adjacent pad sections together; one pad connector connects to the top of each pad section and the second pad connector connects to the bottom of each pad section. Grommet on each pad connector must be on inside edge of pad (closest to jumping mat).

Assembly and Installation Instructions (Type C)

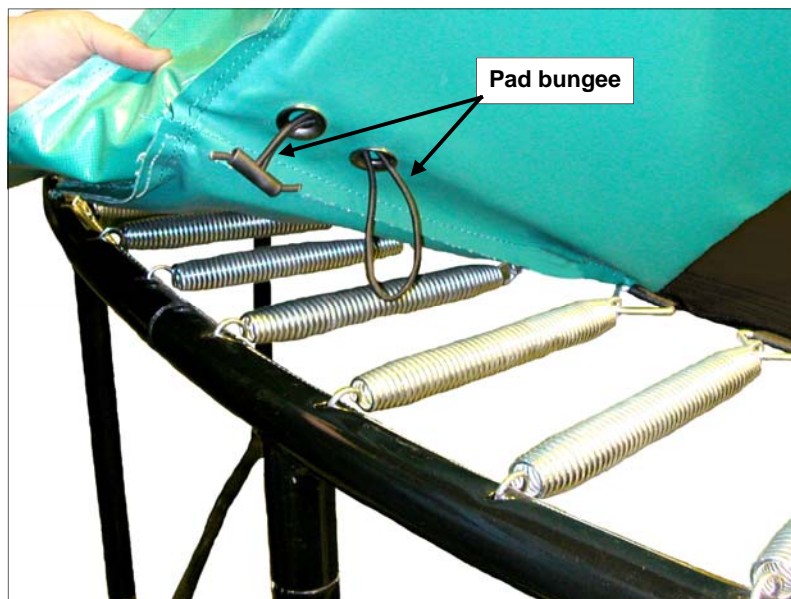

3) Install pad bungees through the 2 metal grommets near outside edge of pad, as shown. Grommets should be on bottom side of pad near each leg.

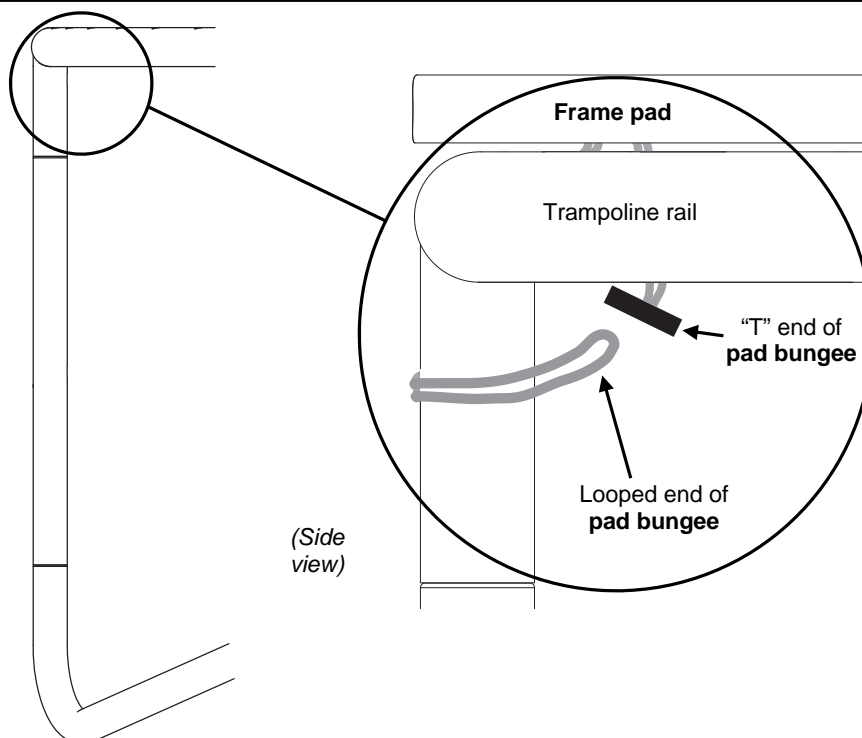

4) Wrap looped end of pad bungee around leg of trampoline, as shown. Then wrap looped end around the "T" on the opposite end of the bungee.

Note: Bungee should NOT wrap around rail of trampoline. It should only wrap around the leg.

Assembly and Installation Instructions (Type C)

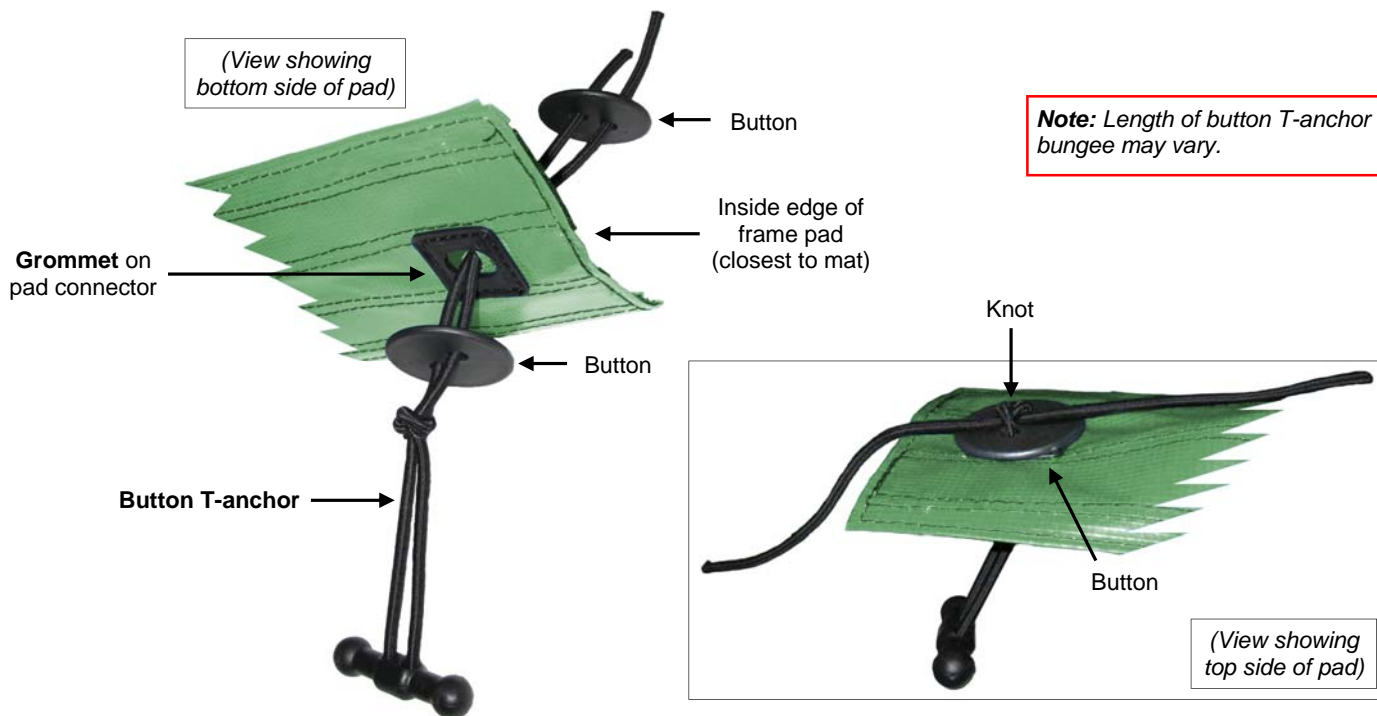

5) If you do *not* have a safety enclosure installed, install a button T-anchor through the grommets in each pair of pad connectors as shown (starting from bottom side of frame pad). Buttons must be flush with pad connectors, and knot must be tied securely to hold top button in place. There should be no slack between the bottom knot and the top knot you just tied.

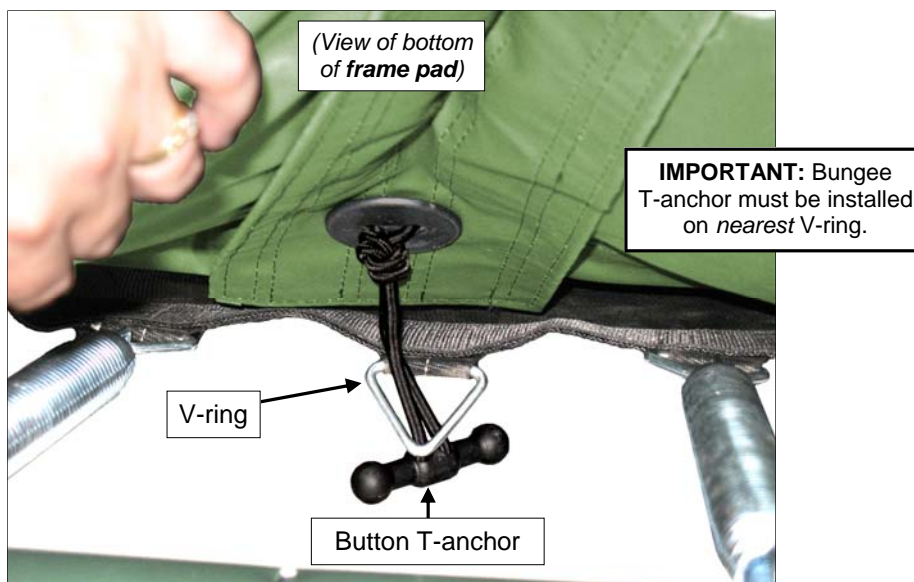

6) Lift frame pad and find a button T-anchor. Remove the spring (and PowerBounce PowerArm if applicable) that is closest to the button T-anchor. Secure T-anchor through V-ring on trampoline mat as shown. Then reconnect the spring (and PowerBounce Power-Arm if applicable).

Your Universal Frame Pad is now installed!

To remove the frame pad, follow the Installation Instructions in reverse order.

Assembly and Installation Instructions

(This page left intentionally blank.)



1 Year Limited Warranty

What is covered by this warranty? This warranty covers any defects in materials or workmanship on all of the components of the AlleyOop Sports 14ft Deluxe Universal Frame Pad, and is extended exclusively to the original retail purchaser.

How long does this coverage last? Warranty coverage for each component begins from the original date of purchase and lasts for 1 year.

What will AlleyOop Sports do? If you return the defective part to AlleyOop Sports as instructed below, AlleyOop Sports will either repair or replace such part, at AlleyOop Sports' discretion, and return it to you.

What is not covered by this warranty? This warranty does not cover expenses of on-site labor, shipping costs, travel, assembly or disassembly, or other charges associated with the repair or replacement of covered components. This warranty also does not cover any problem that is caused by abuse, misuse, commercial or public use, ordinary wear and tear, weathering, acts of God (such as wind and lightning), failure to follow directions, improper installation, improper maintenance, or any silk screened graphics. Rust is a natural occurrence with any outdoor steel product and is likewise not covered by this warranty, to the extent that it does not affect the structural integrity of the part.

ALLEYOOP SPORTS IS NOT RESPONSIBLE OR LIABLE FOR INDIRECT, SPECIAL, OR CONSEQUENTIAL DAMAGES ARISING OUT OF OR IN CONNECTION WITH THE USE OR PERFORMANCE OF THE PRODUCT OR OTHER DAMAGES WITH RESPECT TO ANY LOSS, INCLUDING BUT NOT LIMITED TO ECONOMIC LOSS, LOSS OF PROPERTY, LOSS OF REVENUE OR PROFITS, LOSS OF ENJOYMENT OR USE, COST OF REMOVAL, INSTALLATION OR OTHER CONSEQUENTIAL DAMAGES. SOME STATES DO NOT ALLOW THE EXCLUSION OR LIMITATION OF INCIDENTAL OR CONSEQUENTIAL DAMAGES. ACCORDINGLY, THE ABOVE LIMITATION MAY NOT APPLY TO YOU.

THE WARRANTY EXTENDED HEREUNDER IS IN LIEU OF ALL OTHER WARRANTIES AND ANY IMPLIED WARRANTY OF MERCHANTABILITY OR FITNESS FOR A PARTICULAR PURPOSE IS LIMITED IN ITS SCOPE AND DURATION TO THE TERMS SET FORTH HEREIN. SOME STATES DO NOT ALLOW LIMITATIONS ON HOW LONG AN IMPLIED WARRANTY LASTS. ACCORDINGLY, THE ABOVE LIMITATION MAY NOT APPLY TO YOU.

How to get a defective part replaced:

- 1) Call the AlleyOop Sports Customer Service department at 408-213-2551 to obtain a Return Authorization number. All returns must be pre-authorized.
- 2) Send the part(s) to the designated Service Center, along with a copy of your original sales receipt and a brief written description of the problem, including how it occurred. You must pay freight and insurance to return the part to AlleyOop Sports. At AlleyOop Sports' sole discretion, we may ask you to send photographs in addition to or in lieu of returning the part.
- 3) After inspecting the returned part(s), AlleyOop Sports will make a final determination whether the part is covered by this warranty. We reserve the right to examine photographs or physical evidence concerning parts claimed to be defective prior to making a final determination concerning the claim. A repaired or replacement part will be returned to you. (Shipping charges may apply.) Please allow 3 to 4 weeks for delivery.

This warranty gives you specific legal rights. You may also have other rights which vary from state to state.

JumpSport, Inc.
2055 South 7th Street, Suite A
San Jose, CA 95112

408-213-2551

<http://www.jumpsport.com>