

JumpSport®

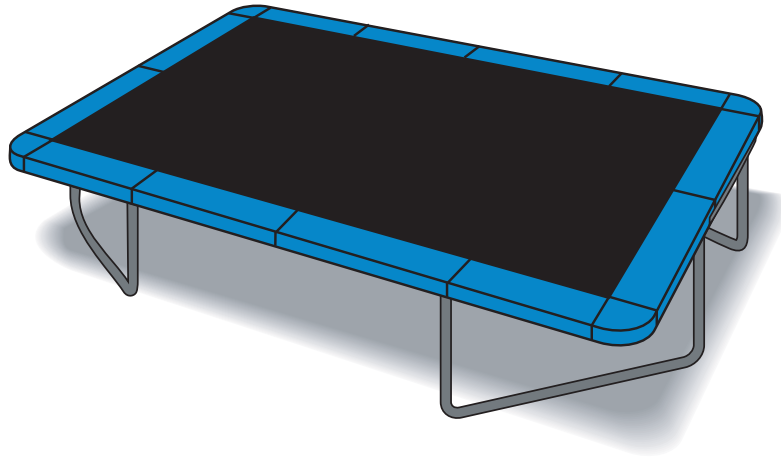

10ft x 17ft StagedBounce Trampoline User's Manual

Assembly, Installation, Care, Maintenance, and Use
Instructions

WARNING

**Read these materials prior to assembling and
using this trampoline and Trampoline Enclosure**



DO NOT attempt or allow somersaults. Landing on the head or neck can cause serious injury, paralysis or death, even when landing in the middle of the bed.



DO NOT allow more than one person on the trampoline. Use by more than one person at the same time can result in serious injury.

Use trampoline only with mature, knowledgeable supervision.

The maximum user weight is 220 pounds. This trampoline is not recommended for use by children under six years of age.

Retain address information for future use.

JumpSport, Inc.
2055 South 7th Street, Suite A
San Jose, CA 95112 U.S.A.

408-213-2551
www.jumpsport.com

Copyright Notice

This material is protected by United States copyright laws and is proprietary to JumpSport, Inc. Disclosure, reproduction, translation, modification, or use of this document by anyone other than authorized employees, authorized users, or licensees of JumpSport without the prior written consent of JumpSport, Inc. is prohibited.

The information in this document is subject to change without notice. JumpSport, Inc. shall not be liable for any damages resulting from technical errors or omissions, which may be present in this document, or from use of this document.

Copyright © 2005-2009, by JumpSport, Inc. All rights reserved.

Printed: 2009

Instruction Manual P/N: INS-P-10899B

JumpSport 10ft x 17ft StagedBounce Trampoline P/N: TRJ-S-11360A

Trademarks

JumpSport®, StagedBounce™, Sure-Lok™, and SureStep™ Trampoline Ladder are trademarks of JumpSport, Inc.

All other brand or product names are trademarks or registered trademarks of their respective companies or organizations.

Patents

This product includes technology associated with one or more of the following U.S. Patents:

No. 6,053,845

No. 6,261,207

No. 6,840,891

No. 6,846,271

No. 7,060,001

Additional Patents Pending.

How to Contact Customer Support

Should you require customer service or technical support for your JumpSport 10ft x 17ft StagedBounce Trampoline, please contact JumpSport' Customer Service department at:

408-213-2551

8:00am – 5:00pm Monday through Friday, Pacific Time



Contents

Chapter 1	Introduction	5
	JumpSport Safety Enclosure	6
Chapter 2	Assembly and Installation Instructions	7
	Preparation	7
	Trampoline Placement	7
	Tools	8
	Parts List	8
	Assembly	10
	Final Steps	24
	Disassembly	24
Chapter 3	Care and Maintenance Instructions	25
	Inspection	25
	Trampoline Mat	25
	Cold Weather Protection	26
	Replacement Parts	26
	Disassembly	26
	Care and Maintenance Safety Checklist	27
	Windy Conditions	28
	Moving the Trampoline	28
	Care	28
Chapter 4	Warning Information	29
	Points of Safety	29
	Landing on Springs or Frame	29
	Bouncing off the Trampoline	29
	Landing Incorrectly on the Mat	30
Chapter 5	Use Instructions	31
	Safety Rules	31
	Basic Skills	32
	Bouncing	32
	Stop Bounce	32
	Arm Action	32
	Bounce Variations	33
	Basic Landing Positions	33
	Seat Drop	33
	Hands and Knees Drop	34
	Front Drop	34
	Series of Drops	35
	Twisting Moves	35
	Swivel Hips	35
	Turntable	36
	Twist Variations	36
	Warranty Information	Last Page

(This page left intentionally blank.)

Congratulations on purchasing an JumpSport Trampoline Safety System! We sincerely believe that you have purchased the finest round trampoline on the market. It has been engineered with safety, durability, and performance in mind. As a result, this product features our SB2 Spring Staging System.

Safe use of a trampoline also requires adequate knowledge of technique, as well as what *not* to do. Please read this manual thoroughly for key points of safety.

Trampolines, being rebounding devices, propel the performer to unaccustomed heights and into a variety of body movements. Therefore, it is emphasized that all purchasers, and all persons using the trampoline, become familiar with the rules for safe use. Misuse and abuse of this trampoline is dangerous, and can cause serious injuries. The purchaser/user of this piece of equipment is assuming a degree of risk for which JumpSport cannot be responsible.

Read this information thoroughly before allowing the trampoline to be used. Keep this manual available for your review, and for review by all potential users. If there are questions please call JumpSport for further explanation.

Caution

JumpSport trampolines are designed exclusively for the home backyard market. Many users of our trampolines are children, and therefore need close supervision and rules to follow while playing on the trampoline. These rules must be enforced by whomever is responsible for the care of the children. It is strongly recommended that the buyer of this product go over the rules and recommendations in the packet of information supplied, including those in this manual. It is also strongly recommended that these rules and recommendations be supplemented with those of your own, for example: the time that jumping is allowed, when neighbors can visit, and so on. These rules and recommendations should be reviewed with anyone who is going to jump on the trampoline. If it is possible, review these rules with the parents or guardians of any visitors who may be jumping on the trampoline. See *Safety Rules* (under the *Use Instructions* section) for more information.

Recommended weight limitation is no more than 220 pounds. Persons at, or near this weight should test the resiliency of the springs prior to extensive bouncing. Do this by jumping lightly on the mat. If the resiliency appears to be weak (mat does not lift the individual when light jumps are made), discontinue bouncing immediately, take off the springs and inspect them. If the springs appear to be stretched out of shape, the mat should not be put back on until the springs have been replaced. Be sure to check the mat for any areas that need re-stitching, or V-rings that may need replacing.

We also urge you to not keep any ladder, step stool, or other climbing device next to the trampoline when use of the trampoline is not supervised by an adult. This precaution helps to prevent access to the trampoline by individuals that are too small, or do not have the physical strength necessary to jump on a trampoline without having the proper supervision.

Introduction



Due to the risks associated with users falling off of trampolines, we strongly urge you to use a JumpSport Safety Enclosure in conjunction with your trampoline. Please call JumpSport if you have any questions about such a device.



JumpSport Safety Enclosure

Studies show that many of the injuries associated with trampoline use in a residential setting are a result of the user falling off of the trampoline and hitting the ground or some other object. For this reason, it is strongly recommended that a **JumpSport Safety Enclosure** be used in conjunction with your trampoline. The JumpSport Safety Enclosure should be used as a supplement to mature, knowledgeable supervision – not a substitute. The JumpSport enclosure can also be locked to prevent unauthorized use. Please contact JumpSport to learn more about our patented Safety Enclosures.

Protect your family with a JumpSport Safety Enclosure.

Diagram 1 JumpSport Safety Enclosure



Assembly and Installation Instructions

2

Preparation

Before you begin assembling your JumpSport 10ft x 17ft StagedBounce Trampoline, make sure your trampoline is in a proper location.

Trampoline Placement



Caution: *When deciding on where to place your trampoline, consider the following:*



WARNING

Overhead Clearance	Adequate overhead clearance is essential. A minimum of 24 feet from ground level is recommended. Provide clearance for wires, tree limbs, and other possible hazards.
Lateral Clearance	Lateral clearance is essential. Place the trampoline away from walls, structures, fences, and other play areas. Maintain a clear space on all sides of the trampoline.
Level Surface	Place the trampoline on a level surface before use.
Lighting	Use the trampoline in a well-lit area. Artificial illumination may be required for indoor or shady areas.
Security	Secure the trampoline against unauthorized and unsupervised use.
Ground Clearance	Remove any obstructions from beneath the trampoline.

Note: *The owner and supervisors of the trampoline are responsible to make all users aware of practices specified in the Use Instructions.*

IMPORTANT: *The best surface on which to place your trampoline is dirt or grass. However, if you plan to install the trampoline on a very hard surface such as concrete or asphalt, a dense foam — similar to what can be found in public playgrounds — should be installed under each leg. Contact JumpSport Customer Service if you have any questions.*

It is the responsibility of the purchaser to become familiar with all of the information in this booklet, to convey the warnings to all users, and to enforce JumpSport' rules for safe use.

This unit is not intended for commercial or public use and is therefore strictly prohibited.

The maximum user weight is 220 pounds.

This trampoline is not recommended for use by children under six years of age.

Assembly and Installation Instructions

Tools

No tools are required for installation of the trampoline. However, safety glasses and gloves are recommended for safety.

Parts List

Your 10ft x 17ft StagedBounce Trampoline is shipped with the parts shown below. The trampoline parts ship in 3 separate boxes which may arrive on different days. If any parts are missing, immediately call JumpSport Customer Service at 408-213-2551.

Note: The long rail pieces will have plugs in the bottoms of the leg sockets to help secure the legs during shipping. The plugs must be removed before Step 1. You may discard the plugs after assembly is complete. See diagram below.

Reference #	Part #	Description	Quantity
1	RAI-A-10895A	Long rail piece, 24 spring notches	2
2	RAI-P-10901A	Corner rail piece, 6 spring notches on top and 6 on bottom	4
3	LEG-P-10903A	Horizontal leg piece	4
4	LEG-P-10900A	Vertical leg piece	8
5	RAI-A-10897A	Short rail piece, 10 spring notches	2
6	MAT-S-10929A	Mat, 92 V-rings	1
7	SPR-P-10727A	Spring, 10 inches	92
8a	POW-P-10379A	PowerArm	16
8b	POW-P-10380A	PowerHook	16
9a	PAD-A-11569A	Long frame pad piece	2
9b	PAD-A-11567A	Short frame pad piece	2
9c	BUN-P-10160A	Pad bungee, with plastic "T" (fits frame pad)	12
10	CAB-P-10116A	Cable tie	1
11	PLC-P-10132B	Warning placard	1

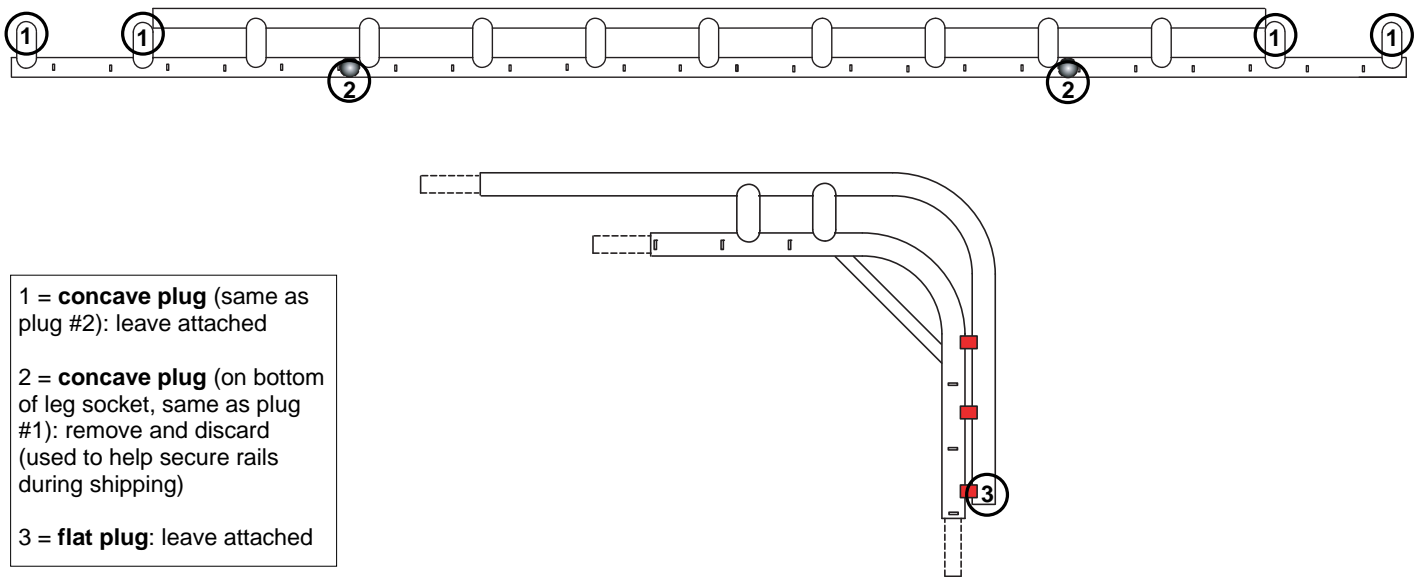

Assembly and Installation Instructions

The following pages contain diagrams, pictures, and written instructions for assembling your 10ft x 17ft StagedBounce Trampoline. The "Ref. #" mentioned in many steps is referring to the "Reference #" column of the parts list on the previous pages.

Familiarize yourself with the Assembly and Installation Instructions before beginning installation.

For installation questions, please contact JumpSport' Customer Service department at:

408-213-2551

8:00am – 5:00pm Monday through Friday, Pacific Time

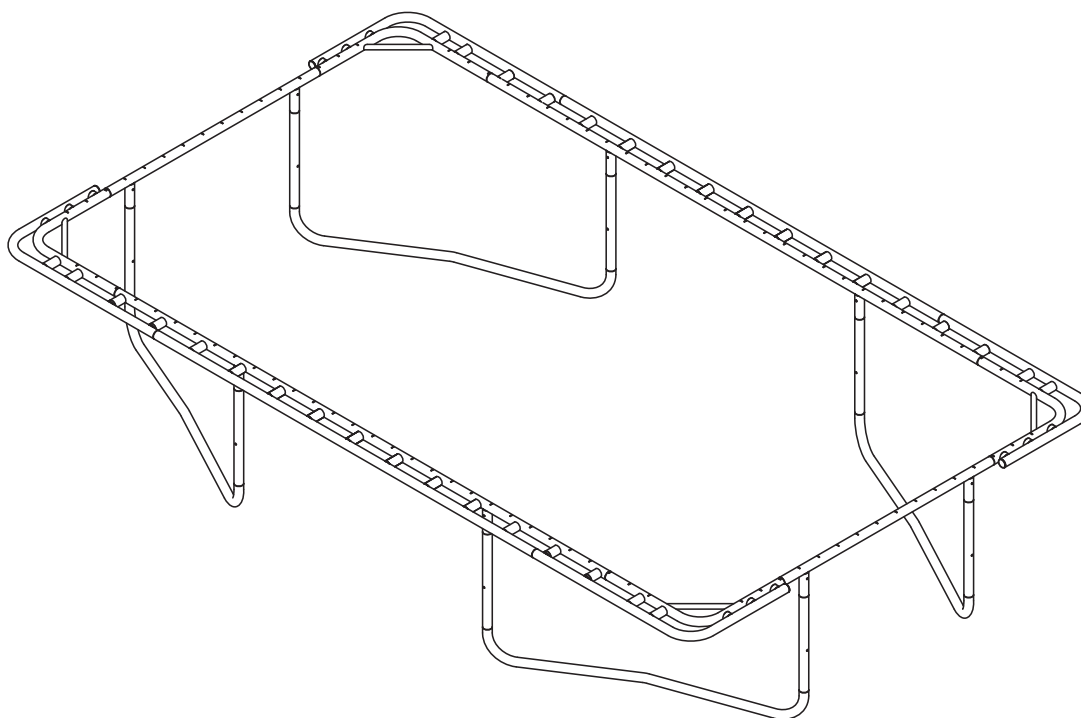
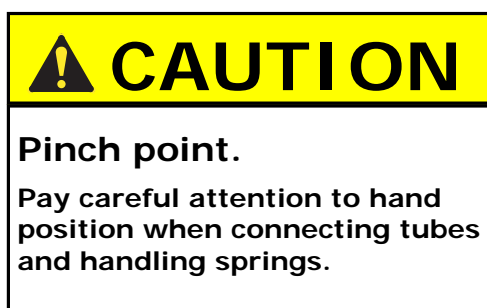

Assembly and Installation Instructions

Assembly

Note: We recommend at least 2 people participate in assembling the trampoline. Use page 8 to help with part names and numbers.

Note: The long rail pieces will have plugs in the bottoms of the leg sockets to help secure the legs during shipping. The plugs must be removed before continuing to Step 1. Do NOT remove any other plugs. See diagram on page 8.

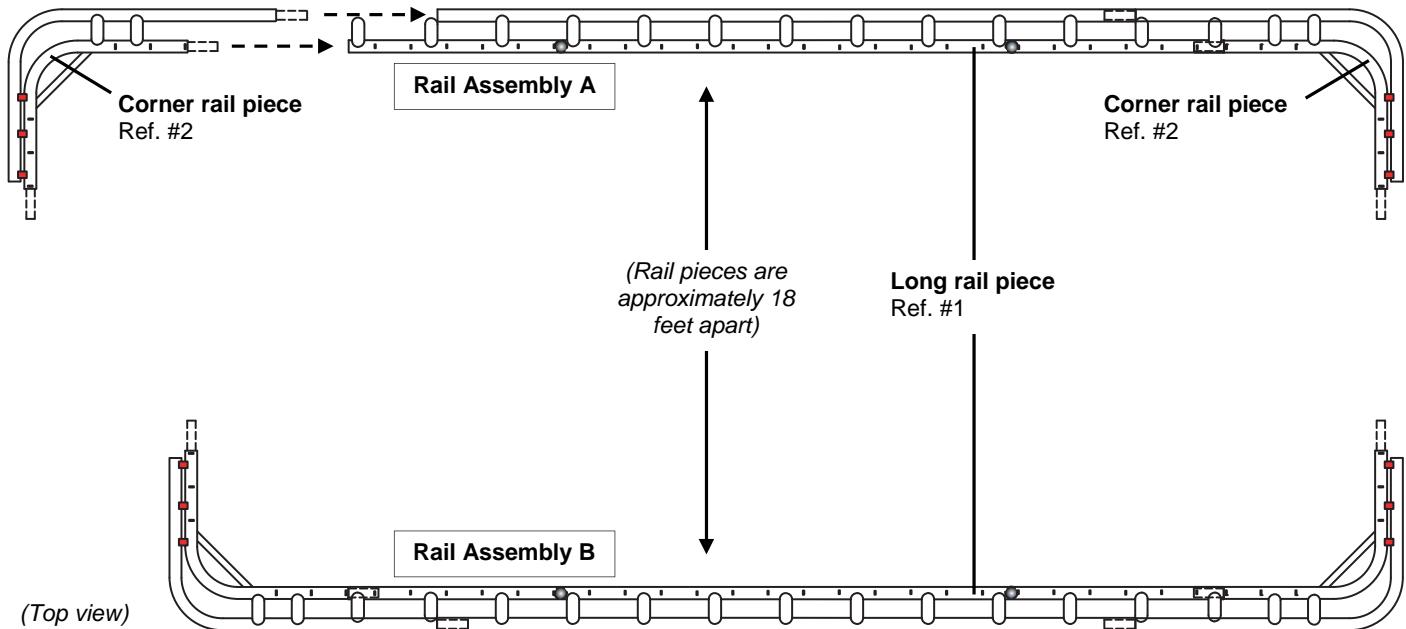

1) Lay each long rail piece on the ground. Position each long rail piece approximately 18 feet apart (if space allows), parallel to each other, with spring notches facing up. Connect each corner rail piece into the ends of each long rail piece. This will create 2 rail assemblies: "rail assembly A" and "rail assembly B".

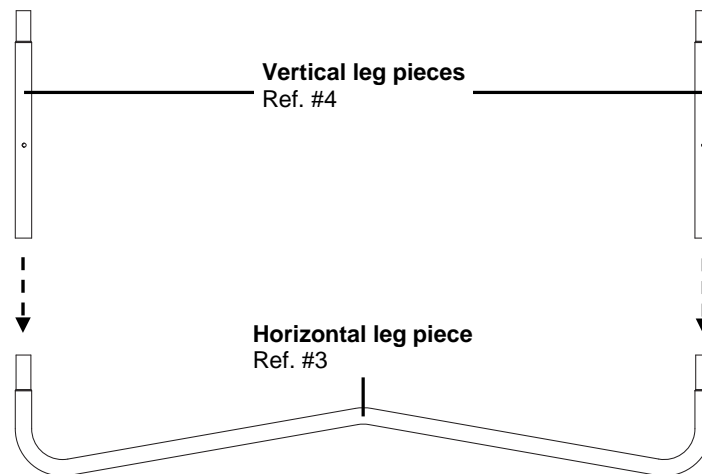

2) Using 1 horizontal leg piece and 2 vertical leg pieces, build a "leg assembly".

>> Repeat with all remaining leg pieces. When finished, you will have 4 complete leg assemblies.

Assembly and Installation Instructions

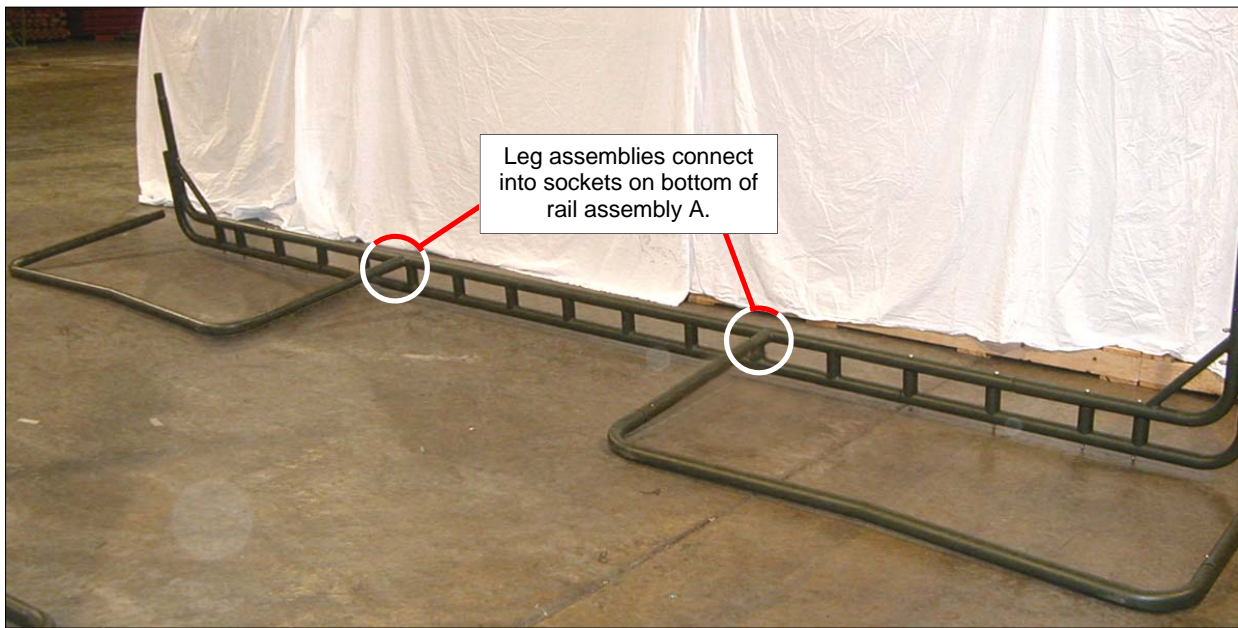

3) Rotate **rail assembly A** onto its outer edge. Insert **leg assemblies** into rail sockets.



4) With the aid of another person, slowly pull a **leg assembly** down toward you until the **leg assembly** is standing upright on the ground. This will leverage **rail assembly A** up into position. Then, rotate the **leg assemblies** toward each other to help make **rail assembly A** more stable.

>> Repeat Steps 3 and 4 using **rail assembly B**.

Assembly and Installation Instructions

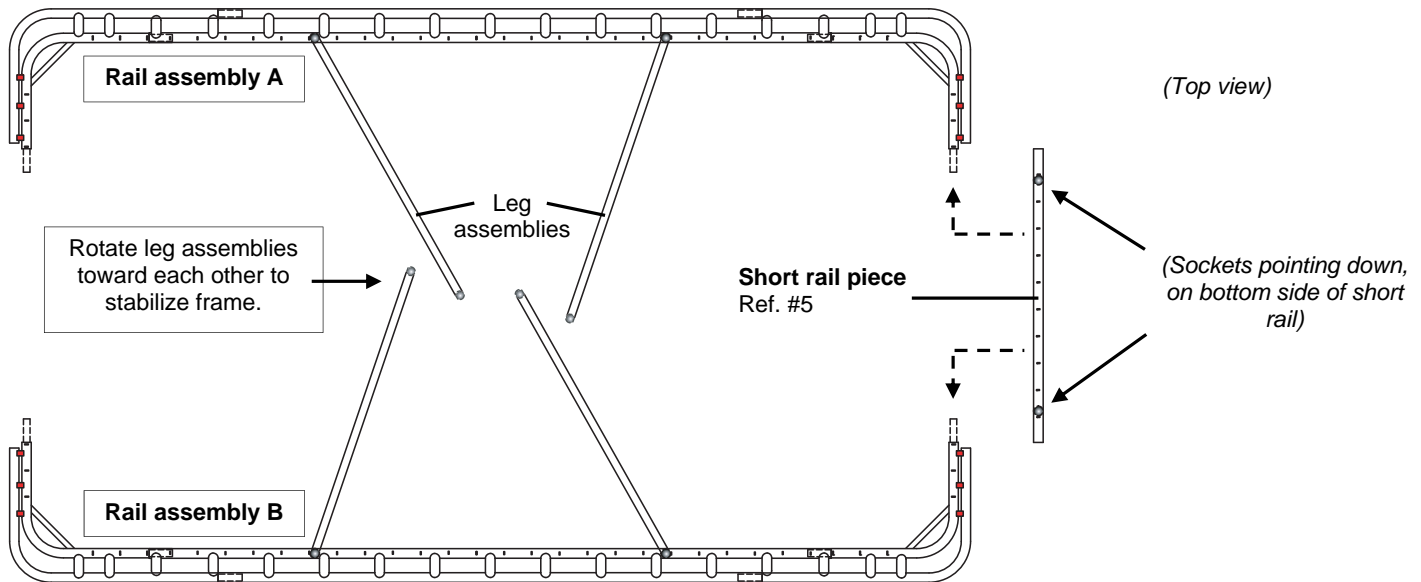

- 5) Have one person hold the **leg assemblies** close together. The other person should go to one end of the rail assemblies and connect a short rail piece to 2 opposite corner pieces.
-

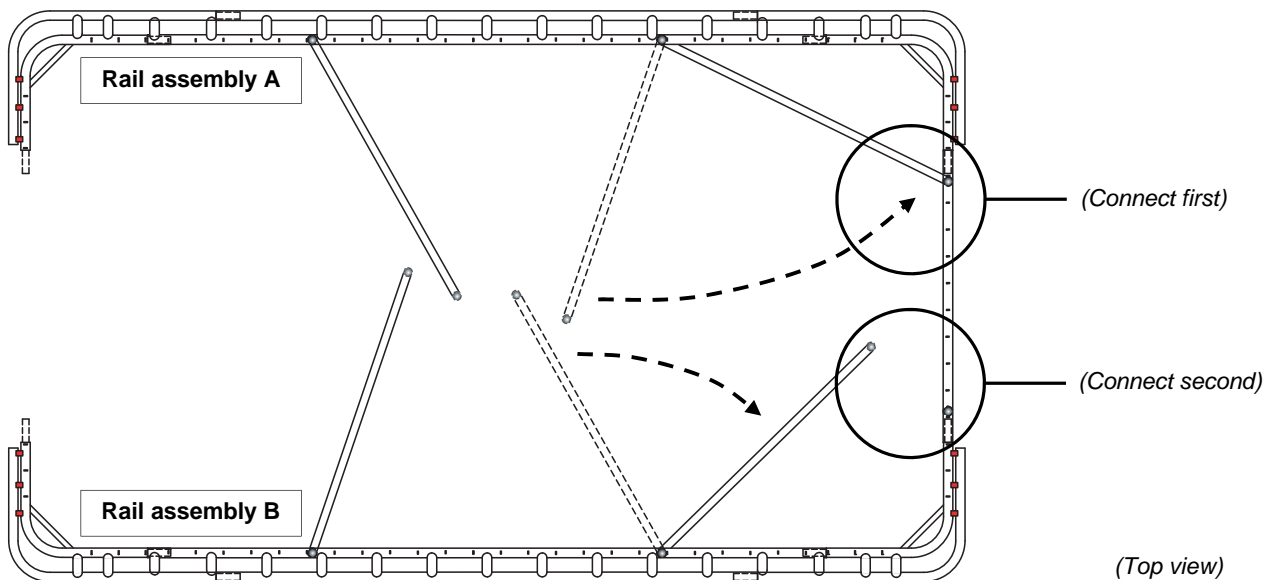

- 6) Connect the closest **leg assemblies** into the sockets on the bottom of the short rail piece, while the other person holds the rail assemblies steady.

Note: You may have to wiggle and lift the rail to get the leg pieces to fit properly into the sockets.

Assembly and Installation Instructions

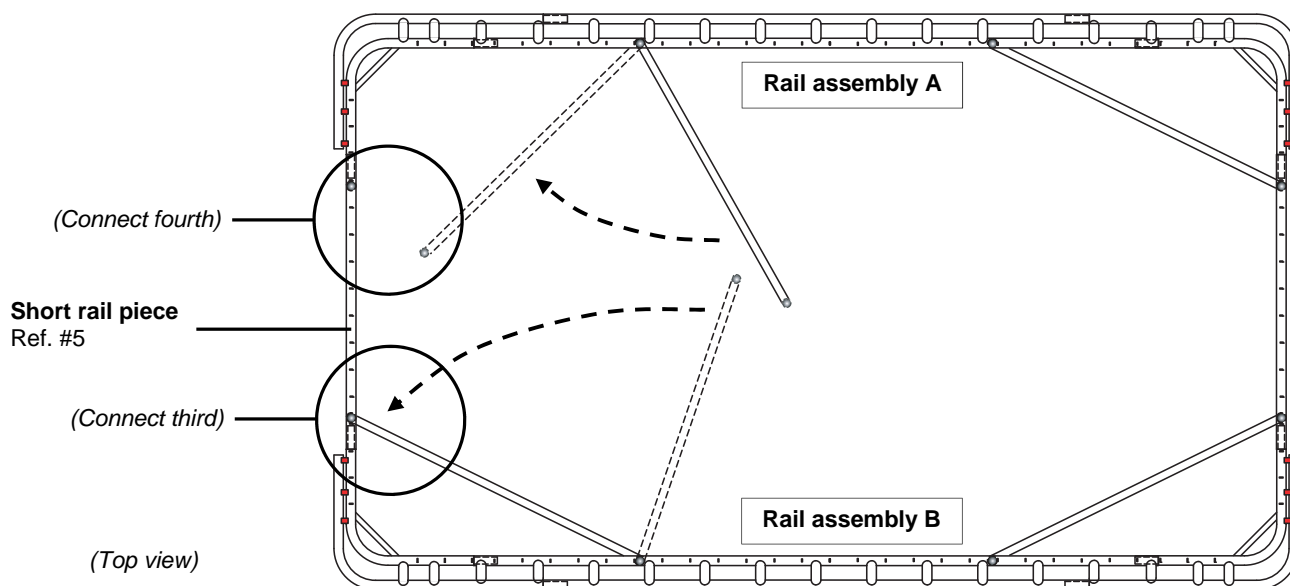

7) Go to the other end of the rail assemblies, and connect a short rail piece to the 2 remaining corner pieces. Now connect the nearby leg assemblies into the sockets on the bottom of the short rail piece.

Note: You may have to wiggle and lift the rail to get the leg pieces to fit properly into the sockets.

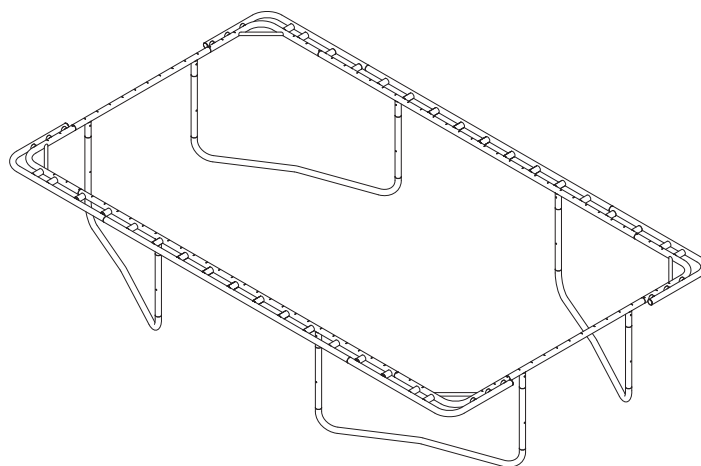
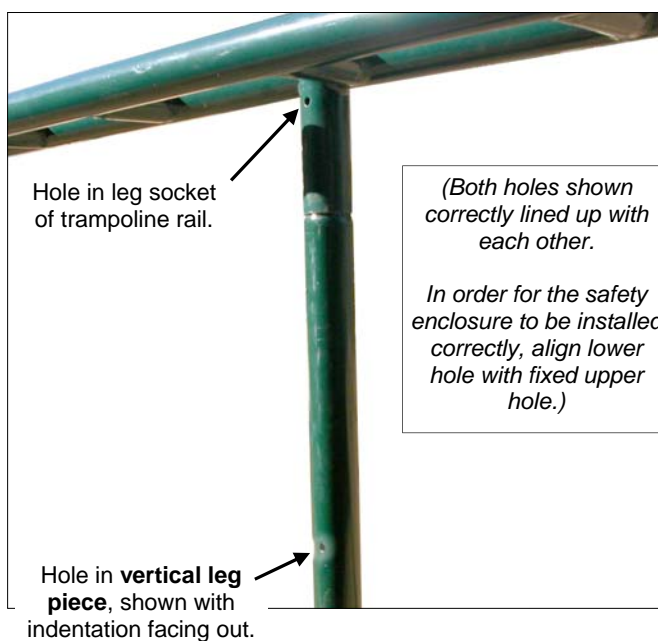

8) Adjust each vertical leg of each leg assembly so that the hole in each vertical leg lines up with the hole in each leg socket. Hole has an indentation on 1 side, and the indentation must face out from trampoline.

9) Completed frame.

Assembly and Installation Instructions

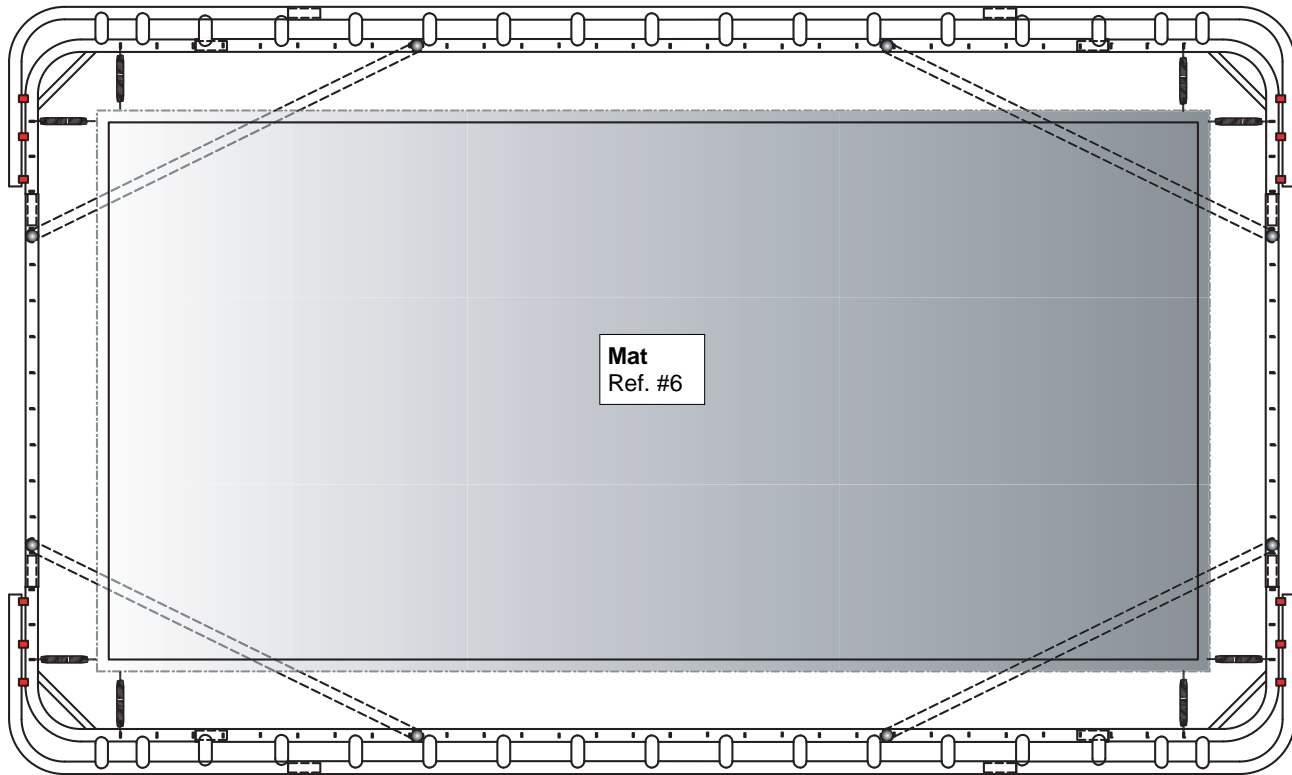

(Top view)

10) Connect jumping mat to trampoline frame by attaching a spring to the two *short* V-rings closest to each corner. Do *not* connect springs to long V-rings. Warning labels on mat must face up.

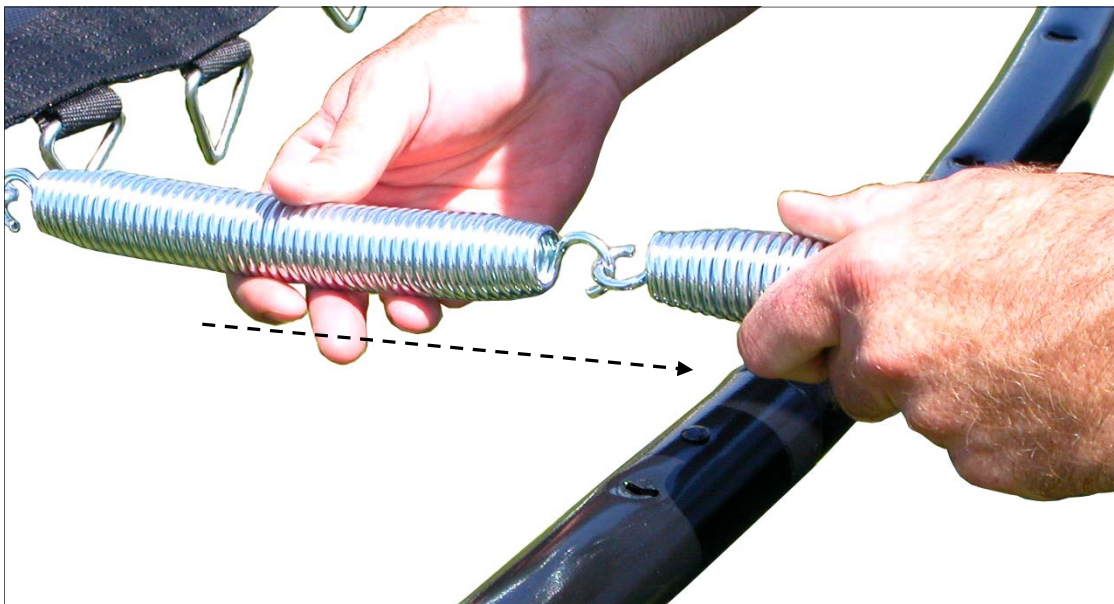

TIP: For easy spring installation, connect spring to V-ring of mat and pull toward you, to connect to frame. Use a second spring as a tool to hook onto the one you are installing.

Assembly and Installation Instructions

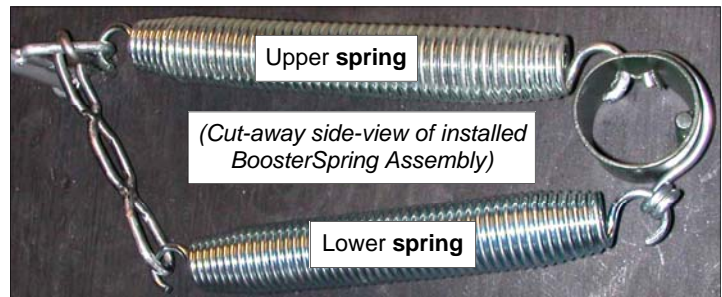
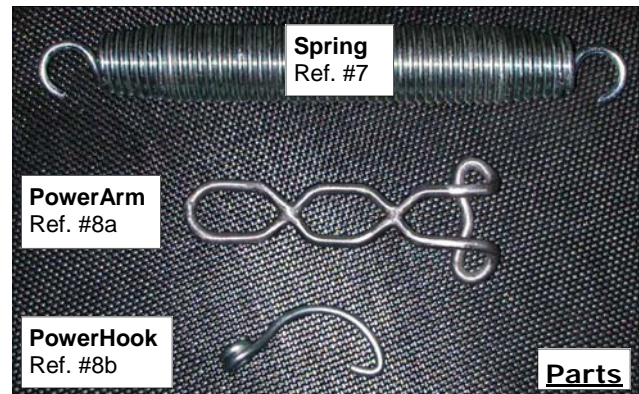
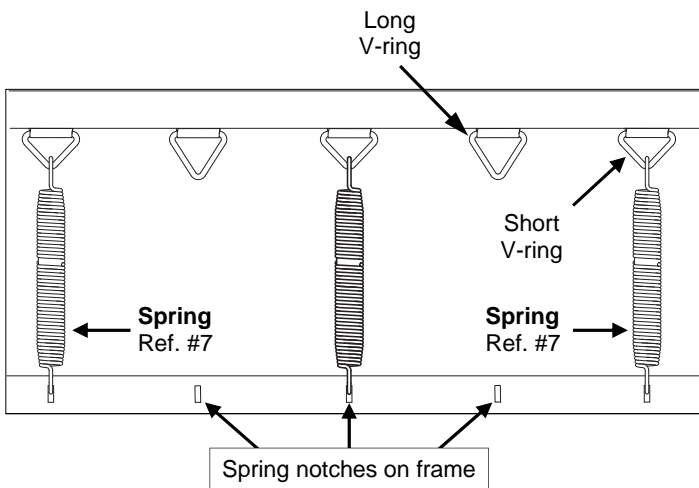
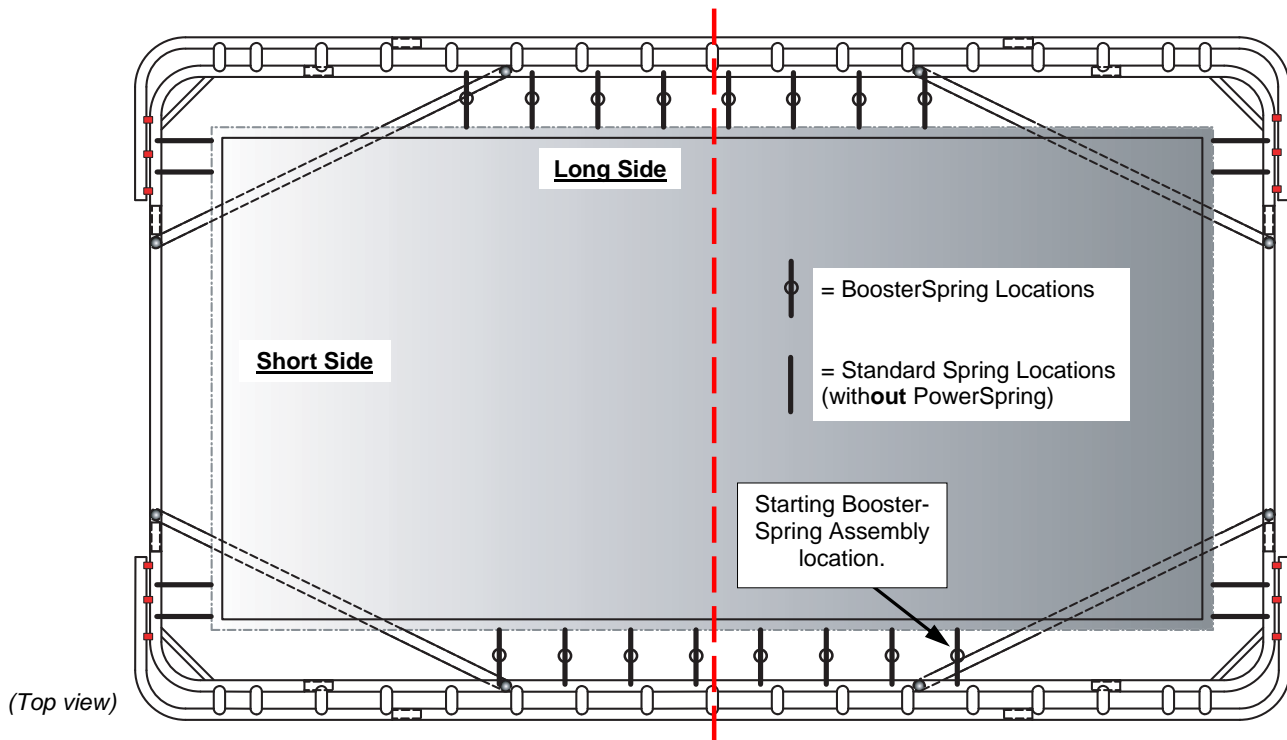

11) Familiarize yourself with the parts used to install BoosterSpring Assemblies to the mat. Locate and become familiar with the starting BoosterSpring Assembly location, as well as where all the BoosterSpring Assemblies will be installed.

Each long side of the trampoline will have a total of 8 BoosterSpring Assemblies installed near the middle of the trampoline. There will be four small V-rings to the left and right of the middle. BoosterSpring Assemblies should be installed on the small V-rings only, and will therefore be installed on every other spring location along the middle.

Note: Due to the staggering of the small and large V-rings on the mat, BoosterSpring Assemblies may not be installed directly across the trampoline from each other.

Assembly and Installation Instructions

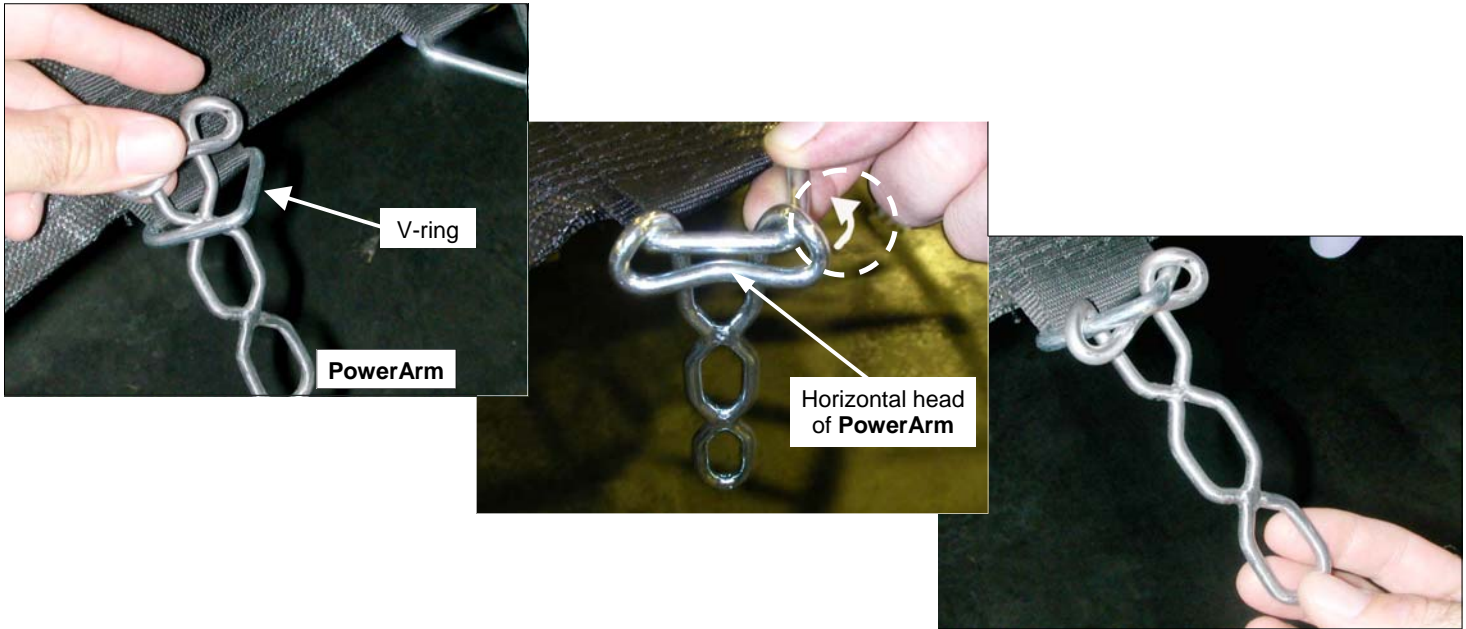

12) Insert a PowerArm into the small V-ring at the starting BoosterSpring Assembly location. Position the horizontal head (top) of the PowerArm along one side of the V-ring, point the tip of the V-ring up into the air, and rotate the PowerArm into place around the tip of the V-ring. The head of the PowerArm will then be locked under the tip of the V-ring so that it is firmly held in place, as shown.

IMPORTANT: The horizontal head needs to go **under** the tip of the V-ring. If you can push the PowerArm up through the V-ring, then the PowerArm is not installed correctly. Repeat this step, and see pictures in this step and the step below for how the PowerArm will look when correctly installed.

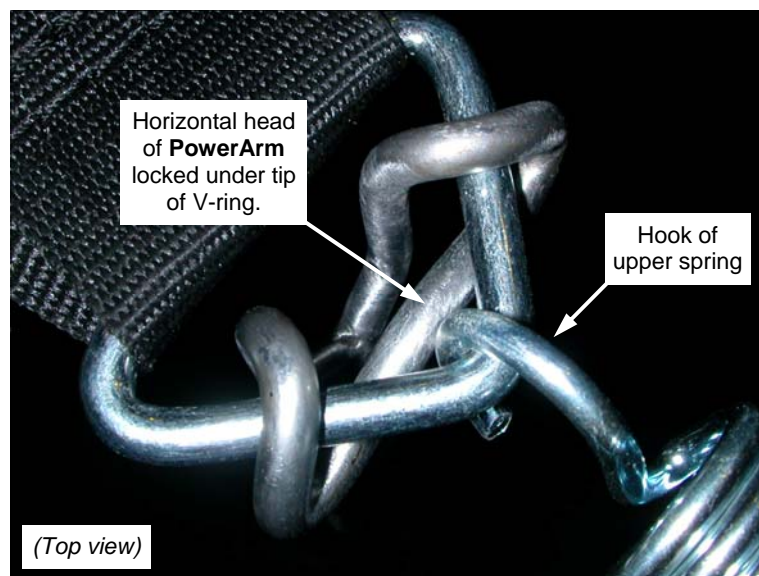

PowerArm properly installed on V-ring is held in place by upper spring.

13) Install upper spring so that the PowerArm is held in place by the spring hook.

Note: The horizontal head of the PowerArm will be situated **below** the V-ring. The hook of the upper spring will be situated between the V-ring and the horizontal head of the PowerArm.

Assembly and Installation Instructions

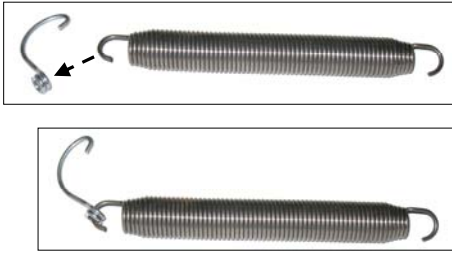

Spring assembly

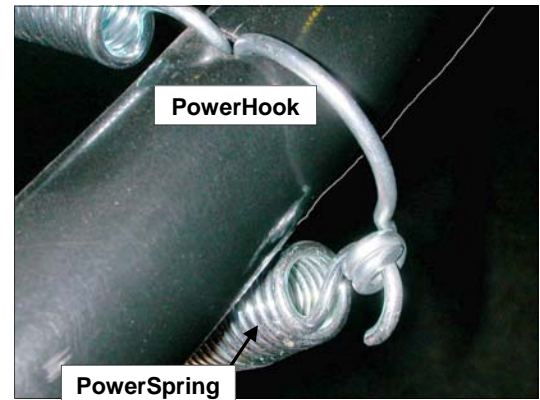

14) Connect a spring to the looped end of a PowerHook to create a “spring assembly.” Connect PowerHook to spring notch on frame, as shown. **Spring assembly** will hang on outside of frame.

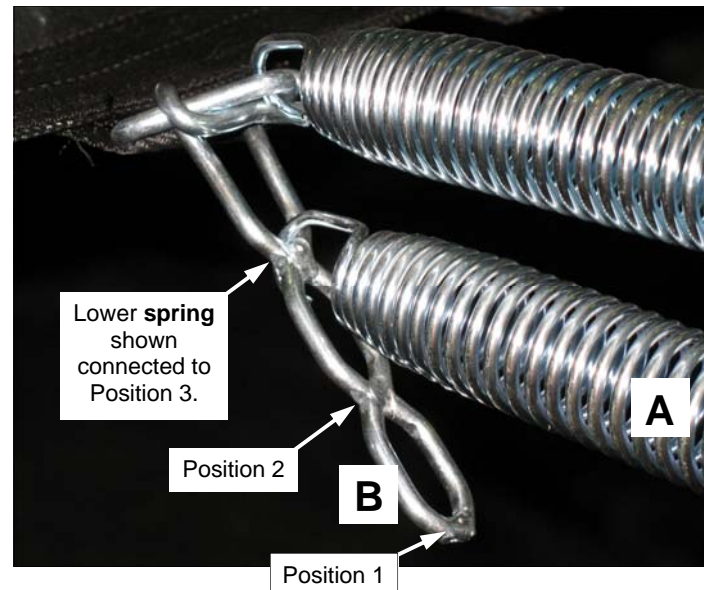

15) Connect the opposite end of the lower spring to Position 3 on the PowerArm (Standard Setting). You now have one “BoosterSpring Assembly” installed.

Assembly and Installation Instructions

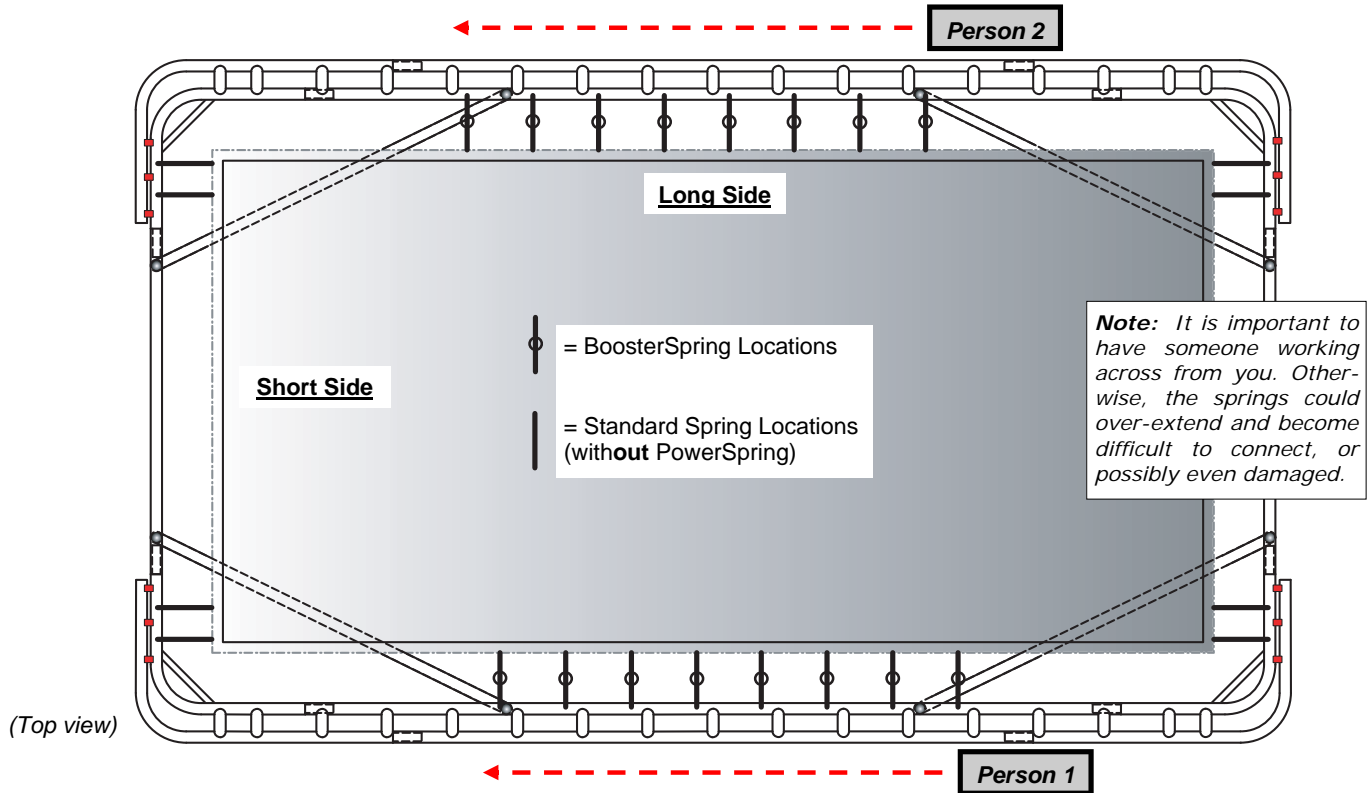

16) Install BoosterSpring Assemblies as shown. Have someone work directly across from you.

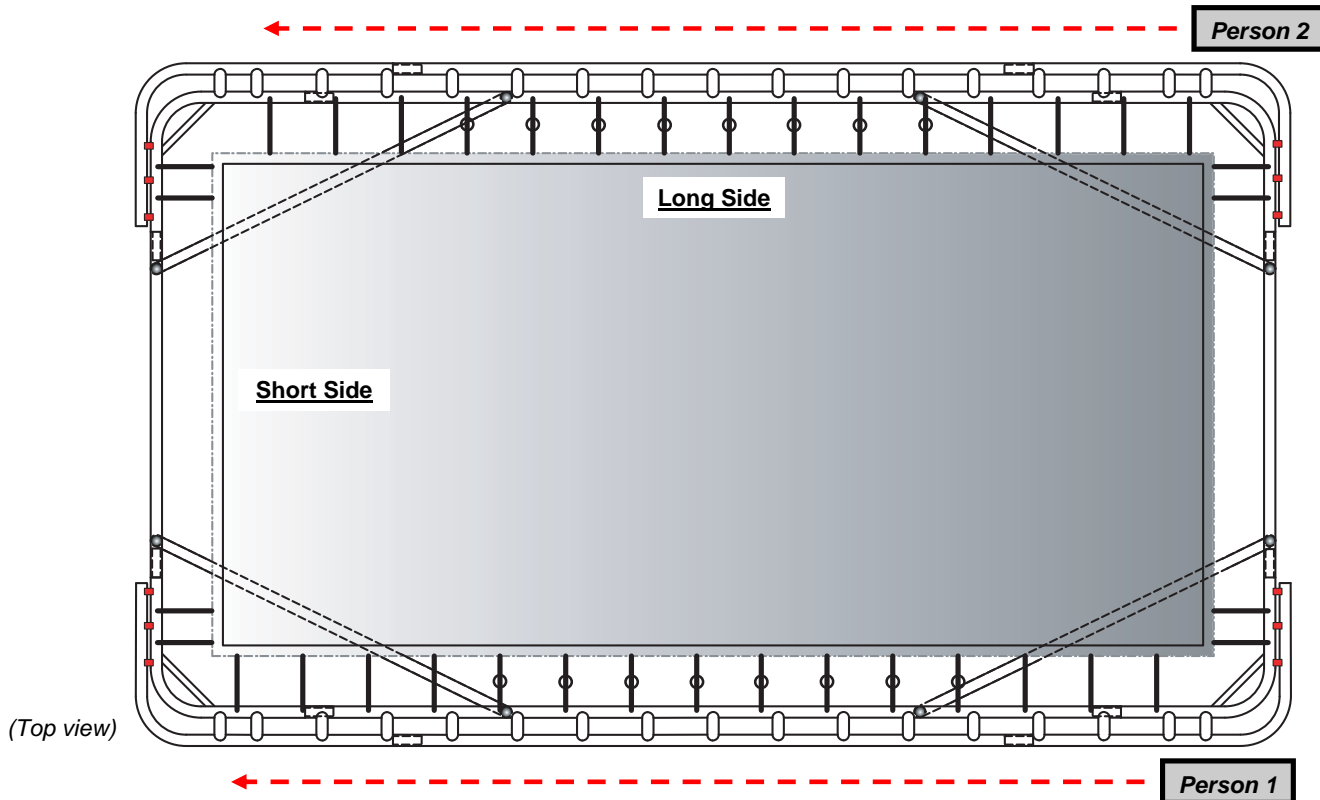

17) Install standard springs on all remaining short V-rings on each long side, starting at one end and working toward the other, as shown. Have someone work directly across from you.

Assembly and Installation Instructions

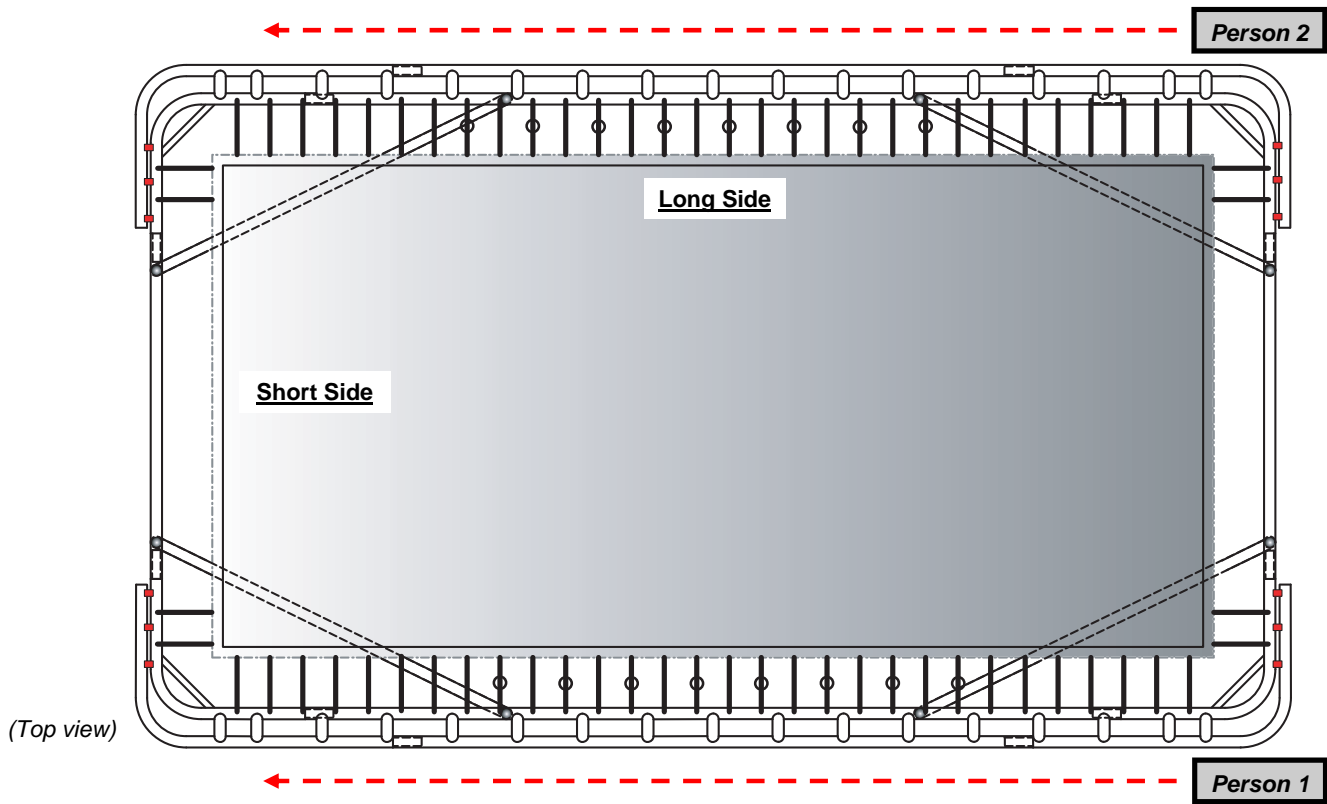

18) Install standard springs on all long V-rings on each long side, starting at one end and working toward the other, as shown. Have someone work directly across from you.

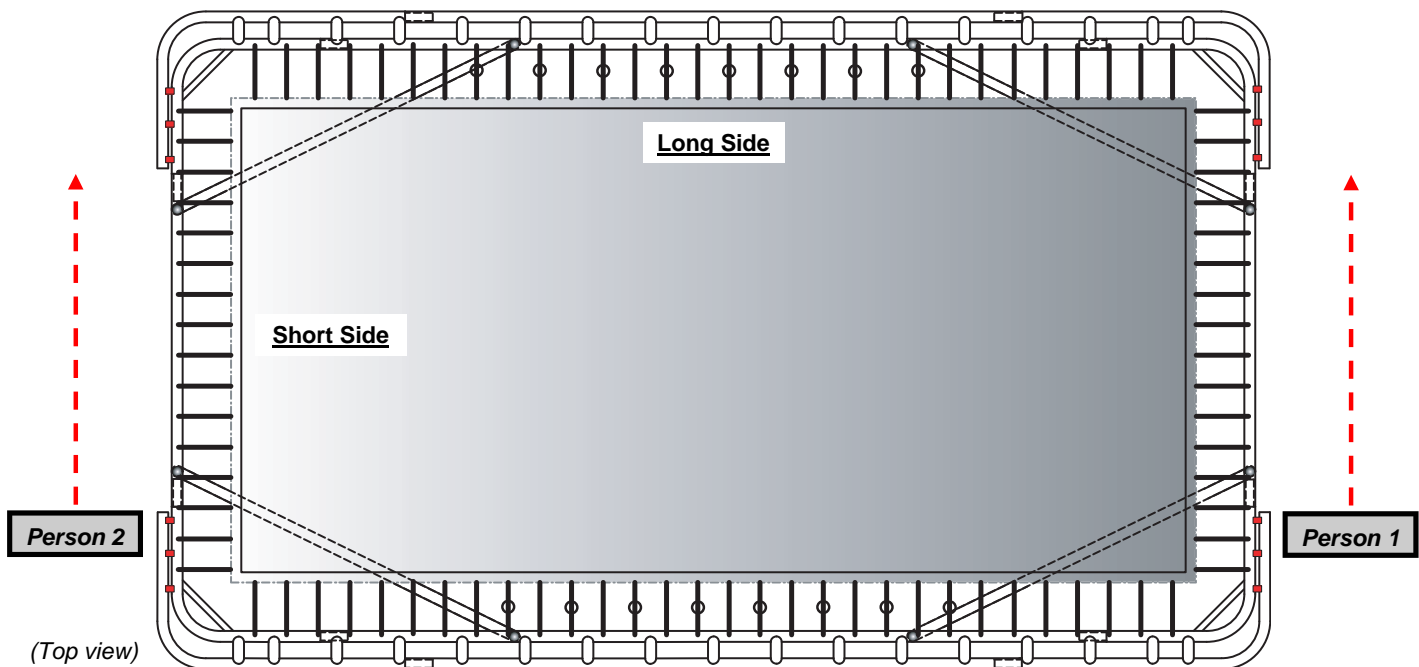

19) Install standard springs on each short side, starting at one end and working toward the other, as shown. Have someone work directly across from you.

Assembly and Installation Instructions

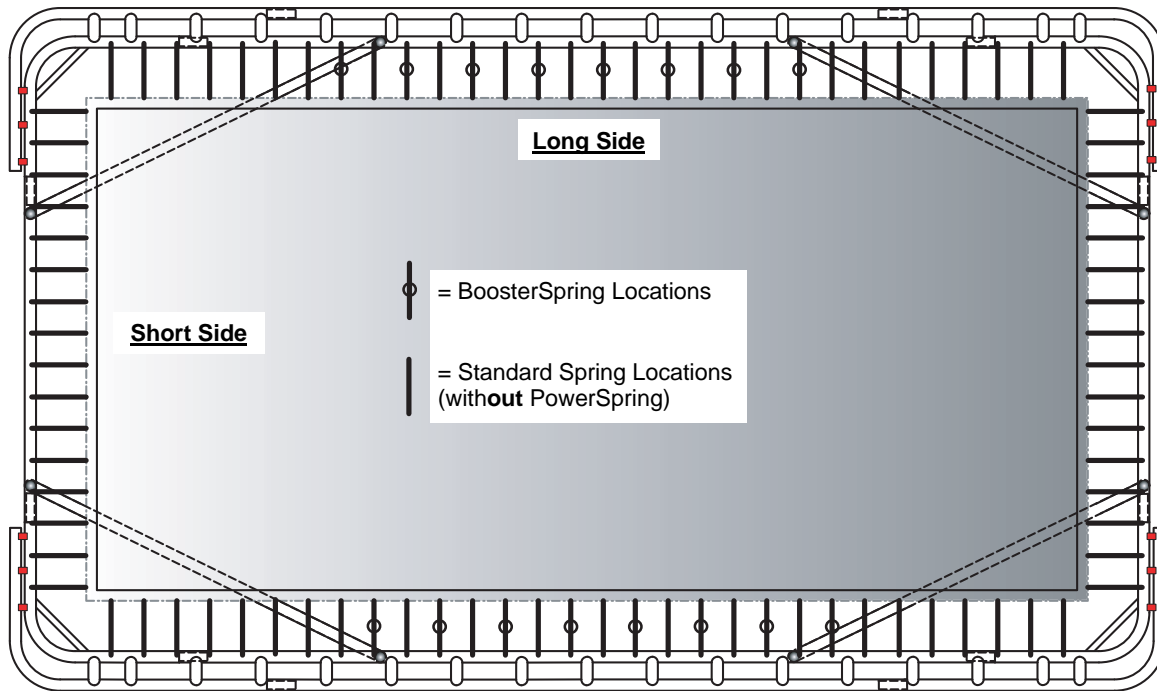

20) All 108 springs should now be connected, as shown.

NOTE: If any PowerArms or PowerSprings come loose after jumping, the PowerArms have not been installed correctly. Repeat Steps 12 and 13, and see the pictures in those steps for how the PowerArm should look after it is properly installed.

Assembly and Installation Instructions

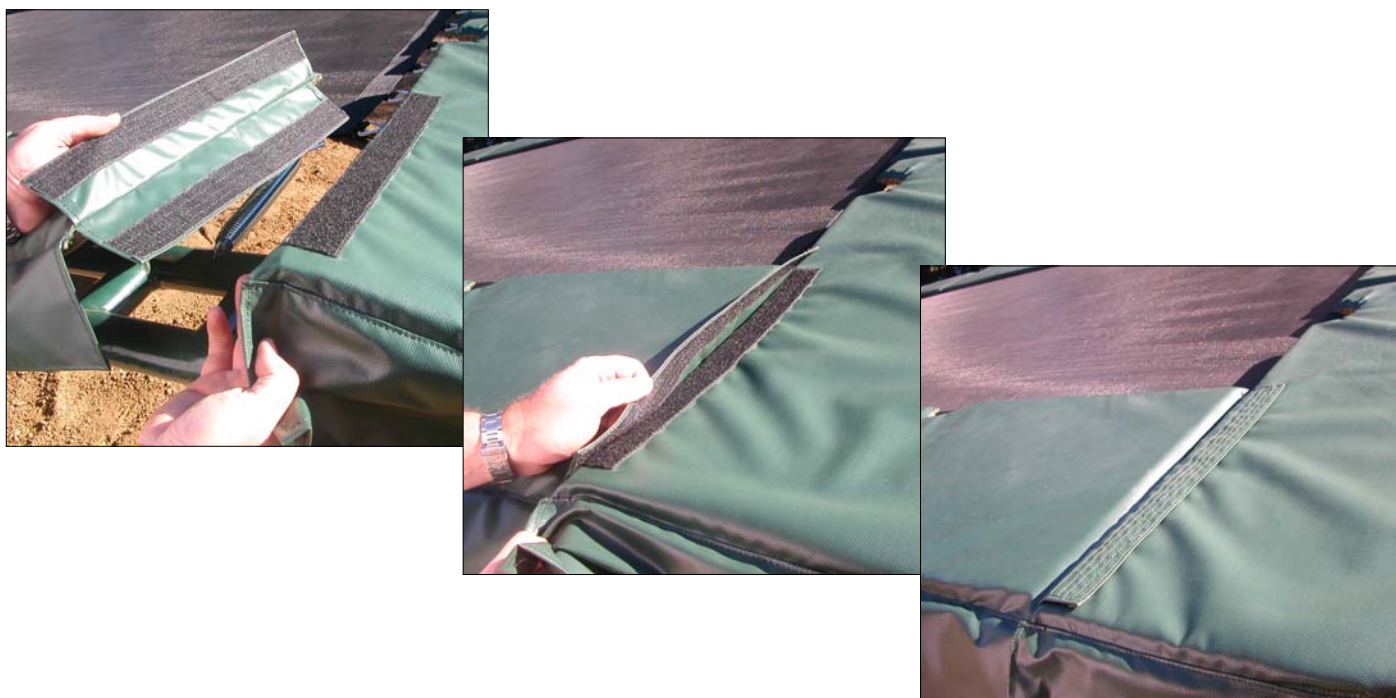

WARNING: *Trampoline use is not recommended without the frame pad installed (see Picture on page 24). The frame pad is designed to reduce the possibility of injury by protecting the user from coming into contact with the frame and springs of the trampoline. It is very important that you properly and securely attach the frame pad to the frame, and that it is in the correct position prior to using the trampoline.*

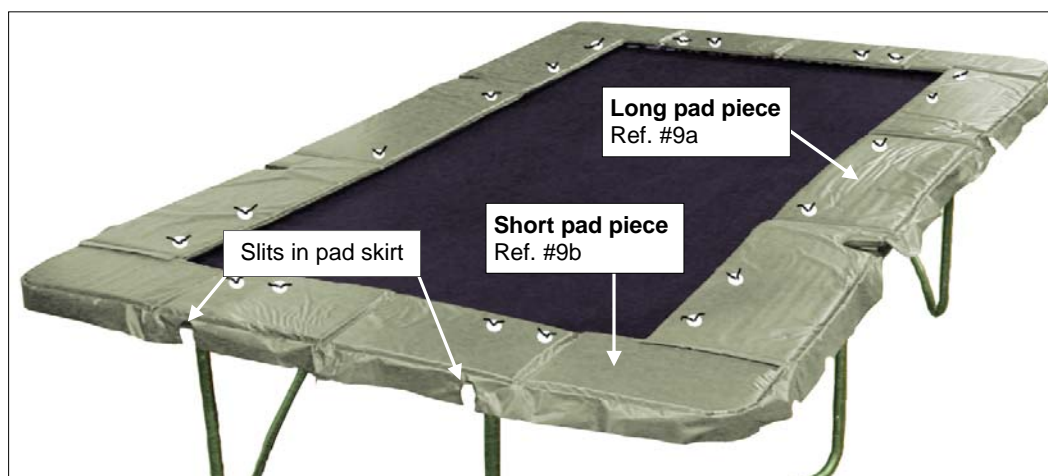

21) Line up pads so they completely cover all springs and rail pieces, on all sides of the trampoline. Connect each pad section together using Velcro pieces at each end of pad. Velcro on each long pad piece will connect to top and bottom of each short pad piece.

Assembly and Installation Instructions

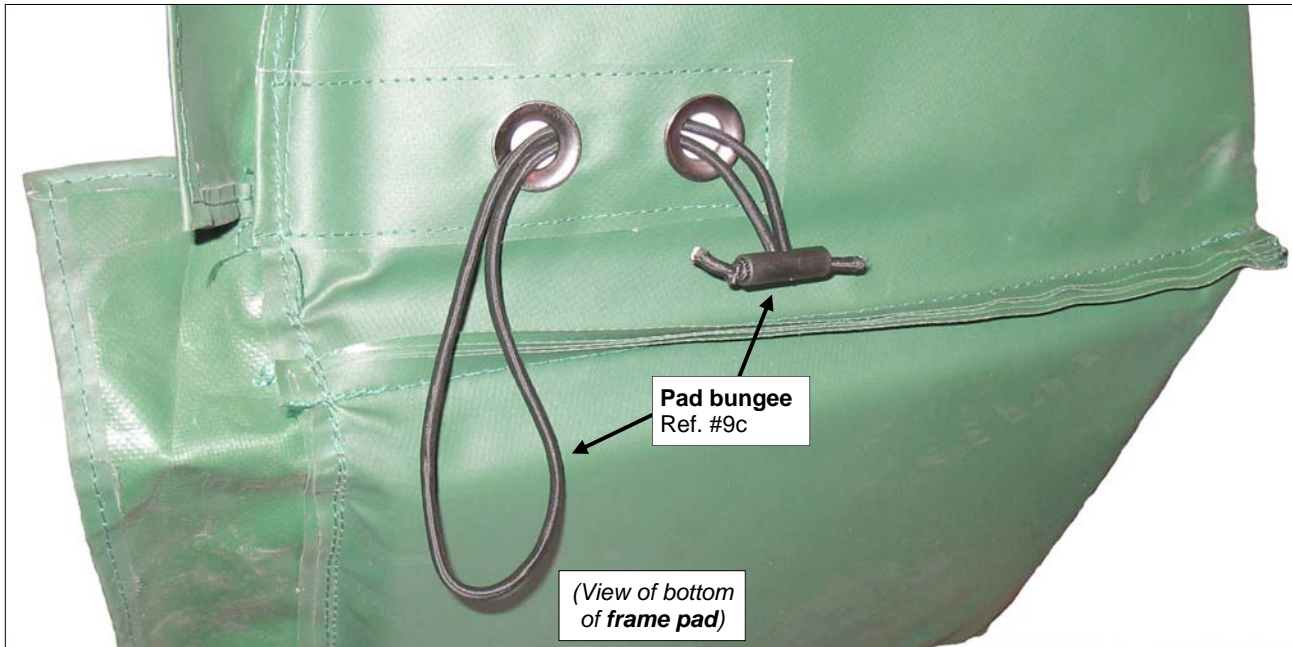

22) Install pad bungees onto bottom side of pad, as shown.

Note: Do not use pad bungees to secure frame pad around leg of trampoline at this time. This will be done after installing the safety enclosure poles in a later step.

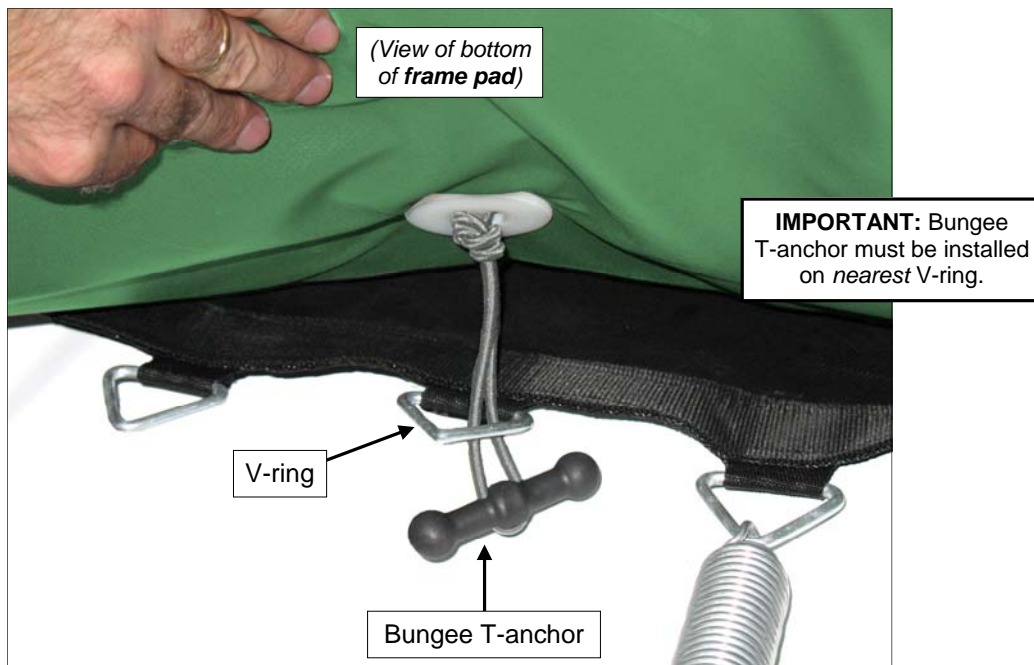

23) Lift frame pad and find a factory-installed bungee T-anchor. Remove the spring that is closest to the bungee T-anchor. Secure bungee T-anchor through V-ring on trampoline mat as shown. Then reconnect the spring.

>> Repeat at every location on bottom of pad where you see a bungee T-anchor until all 16 bungee T-anchors are securely fastened to V-rings.

Assembly and Installation Instructions

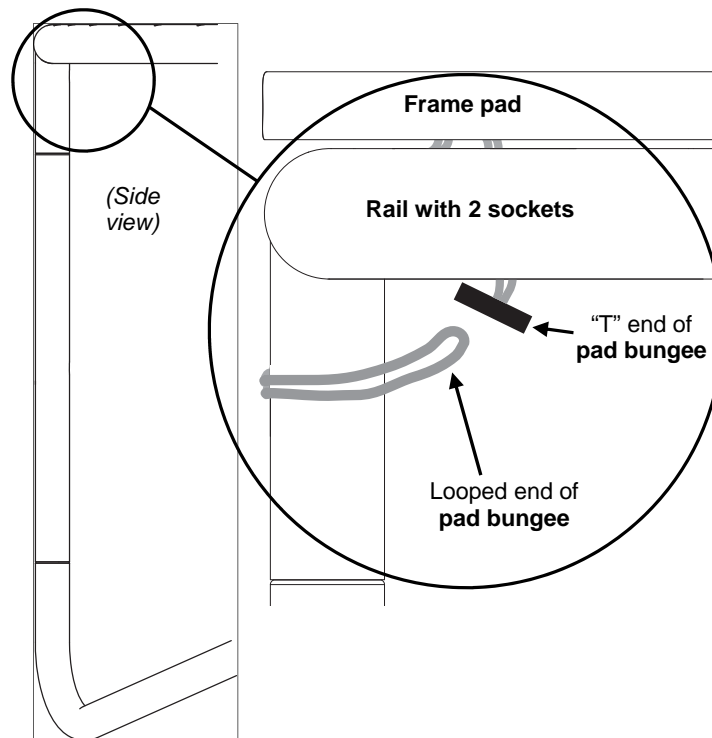

24) Wrap looped end of pad bungee (located on bottom side of frame pad) around leg of trampoline. Then wrap looped end around the "T" on the opposite end of the bungee.

Note: Bungee should NOT wrap around rail of trampoline. It should only wrap around the leg.

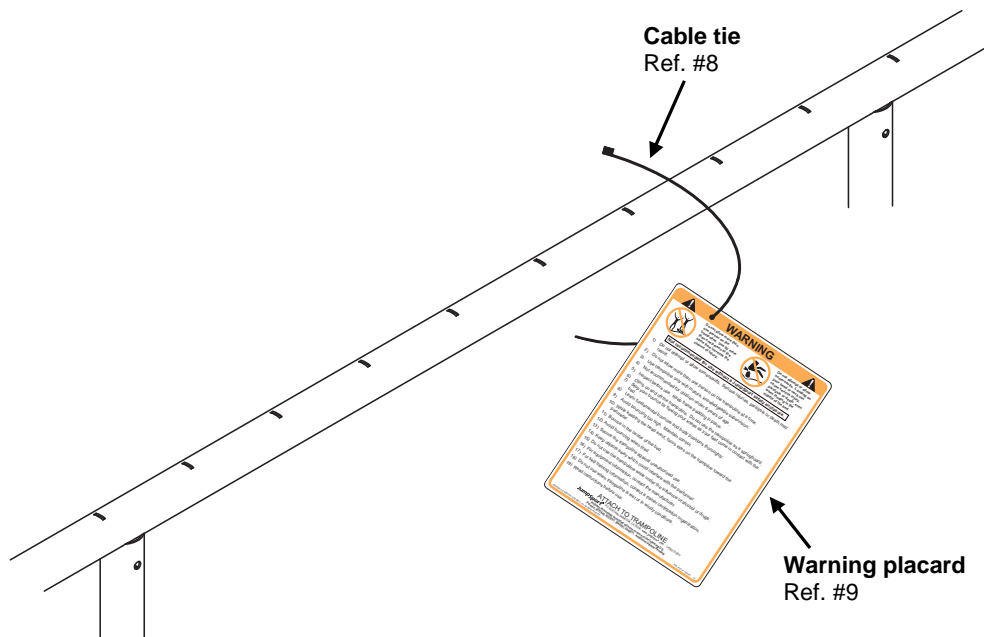

25) Attach warning placard to rail of trampoline using cable tie. Place placard where it will be most easily seen by those accessing the trampoline.

Assembly and Installation Instructions

Final Steps

Assembly is now complete! Make sure all parts are securely assembled. Before using your 10ft x 17ft StagedBounce Trampoline, familiarize yourself and all users with the *Care and Maintenance Instructions*, *Warning Information*, and *Use Instructions* included in this manual.

To register your 10ft x 17ft StagedBounce Trampoline, visit our webpage at www.jumpsport.com and click on the [Product Registration](#) link.



WARNING: *Trampoline use is not recommended without the frame pad installed (see Picture A, below). The frame pad is designed to reduce the possibility of injury by protecting the user from coming into contact with the frame and springs of the trampoline. It is very important that you properly and securely attach the frame pad to the frame, and that it is in the correct position prior to using the trampoline.*

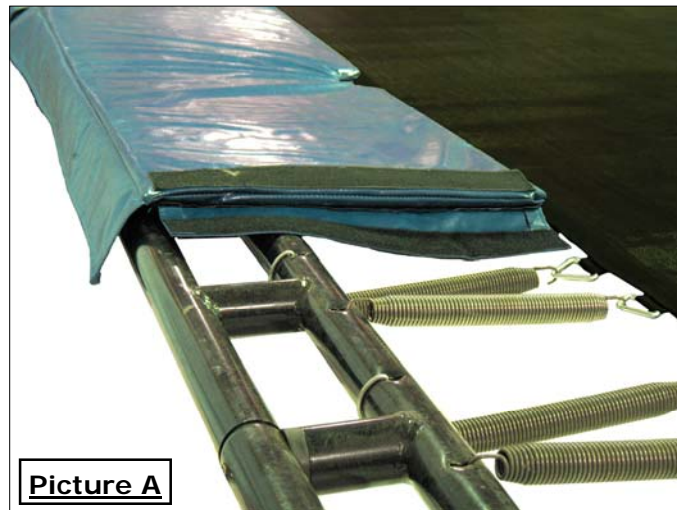

Picture A

**Frame Pad Placement - Showing Correct Placement over Frame Rails and Springs
(Section of frame pad removed for clarity. Be sure pad is completely installed before use.)**

Disassembly

To disassemble the 10ft x 17ft StagedBounce Trampoline, follow the assembly steps in reverse order. Do not attempt to disassemble any rail pieces before the mat and springs have been removed.

For more information about
the SureStep Ladder,
the Trampoline Anchor Kit,
and other great trampoline accessories,
visit our website at www.jumpsport.com

Care and Maintenance Instructions

Your JumpSport trampoline is made using quality materials and is finely-crafted to provide you and your family with many years of enjoyment and exercise. Proper maintenance and care will help to prolong the life of the trampoline and reduce the possibility of injury.

All trampolines require maintenance at some point. Springs may need to be replaced, rail pieces may become bent, stitching in the mat and frame pads may rot out. The following maintenance guidelines should always be observed.

Inspection

Inspect the trampoline before each use and replace any worn, defective, or missing parts. The following conditions could represent potential hazards:

- Missing, improperly positioned, or insecurely attached frame padding
- Puncture, frays, tears, or holes worn in the bed or frame padding
- Deterioration in the stitching or fabric of the bed or frame padding
- Ruptured springs
- A bent or broken frame
- A sagging bed
- Sharp protrusions on the frame or suspension system

Note: The “bed” mentioned above and elsewhere in this manual, refers to the jumping surface (generally referred to as the “mat”). The “frame” mentioned refers to the rail assembly pieces of the trampoline.

If any of the above conditions exist, your 10ft x 17ft StagedBounce Trampoline must be disassembled or otherwise protected against use until the condition is remedied.

Trampoline Mat

An item that poses one of the greatest hazards, is worn out or rotten stitching around the trampoline mat (bed). Stitching may fail within two or three years or earlier due to excessive use or exposure to extreme weather. In most cases, evidence of deterioration will make itself known in the form of:

- Broken stitching around the edge of the mat
- Rotten or frayed fabric at the V-ring straps



Caution: If any deterioration is found, all bouncing must cease and the trampoline must be disassembled or otherwise protected against use until the condition is remedied.

The mat should be replaced with the appropriate JumpSport part. Remember, the only thing between the jumper and the ground is the mat. If a deteriorated mat is not inspected properly, further jumping could cause the mat to pull away from the straps in a large area and the jumper may land on the ground, which could cause serious injury.

Care and Maintenance Instructions

Cold Weather Protection

The 10ft x 17ft StagedBounce Trampoline is designed for year-round outdoor use. However, in climates of cold weather where snow and ice are common, we recommend the trampoline mat, springs, and frame pad be removed and stored in a dry area out of the sun. To remove these parts, simply complete the instructions for installing them in reverse order.

Ice and Snow

Use extreme care in removing any ice and snow that may have accumulated on the mat before removing the mat for storage. We suggest using a high pressure water hose and spraying upward from underneath the trampoline, starting at the mats lowest point. Another option is to pour hot water on the ice and snow to melt it away. Left unattended in snow and ice, your trampoline mat will accumulate weight in the middle, causing damage to your springs. **This type of damage is not covered by warranty.**

Do not use a sharp object - such as a shovel, hoe, or garden rake - to remove ice or snow as this may damage the mat. **This type of damage is not covered by warranty.**

Replacement Parts

All replacement parts should be ordered through JumpSport. Stores that repair shoes, awnings, or tents, as well as upholstery shops, do not have the proper materials, equipment, or methods for the proper/safe repair of trampoline mats and frame pads.

Call **JumpSport** at 408-213-2551 if you need replacement parts, or have any questions.

If any warning labels or signs become unreadable or missing, call JumpSport for free replacements.

Trampoline mats should be completely replaced if any tear or hole is greater than one inch in length. Patches over larger holes will eventually fail, creating a potential for hazardous injury.



Caution: *Do not repair trampoline mats with holes greater than one inch.*

Disassembly

To disassemble, follow the assembly steps in reverse order. Do not attempt to disassemble any rail pieces before the mat and springs have been removed. See the Assembly Instructions beginning on page 10.

Care and Maintenance Safety Checklist

Note: Inspect the trampoline before each use and replace any worn, defective, or missing parts.

Frame Pad

Our frame pad reduces the risk of accidental injury due to falling onto the frame railing and gives minimal resistance to striking or falling on and through the springs. The frame pad life-expectancy is one to two years. To increase life of pad:

- Do not allow jumpers to stand or sit on pad
- Do not allow jumpers to grab pad in order to pull themselves onto trampoline
- Do not allow sharp, abrasive objects to come in contact with the pad surface
- If you have a safety enclosure installed, rotate the pad periodically to spread out wear and tear

Check for...	Necessary Action	Safety Check	
		Safe	Unsafe
Vinyl deterioration	Replace	_____	_____
Foam deterioration	Replace	_____	_____
Missing pads	Replace	_____	_____
Improperly attached pads	Reattach (see pad installation section of instructions)	_____	_____
Stitching deterioration	Re-stitch	_____	_____

Trampoline Mat

Make sure the trampoline is visually inspected by a responsible adult, checking the stitching carefully at each V-ring before every use. See *Trampoline Mat* on page 25 for more information.

Check for...	Necessary Action	Safety Check	
		Safe	Unsafe
Bent or missing V-rings	Replace V-rings	_____	_____
Faded and breaking top thread	Replace	_____	_____
Brittle or tearing V-ring straps	Replace	_____	_____
Cuts, tears, or holes on mat	Patch (holes greater than one inch cannot safely be repaired)	_____	_____
Missing warning labels	Call JumpSport for replacement	_____	_____

Springs

The life of a set of springs is three to five years depending on weight of jumpers, frequency of use, and care of the trampoline.

Check for...	Necessary Action	Safety Check	
		Safe	Unsafe
Over-stretched springs	Replace	_____	_____
Missing springs	Replace	_____	_____
Weak (soft) springs	Replace	_____	_____

Care and Maintenance Instructions

Frame The life of your JumpSport trampoline frame should last for many years, depending upon the weather in the area where you live.

Check for...	Necessary Action	Safety Check	
		Safe	Unsafe
Rust	Clean and paint	_____	_____
Structural failure	Replace	_____	_____
Bent frame	Repair or replace part	_____	_____
Sharp protrusions	Repair	_____	_____
Missing warning labels	Call JumpSport for replacement	_____	_____

Safety Rules Review this manual with all jumpers. Maintain all warning labels and signs. If labels or signs become lost or unreadable, write or call JumpSport for free replacements.

Windy Conditions

It is possible for the trampoline to be blown about by a high wind. If you anticipate high winds, the frame should be secured to the ground with the use of a JumpSport Trampoline Anchor Kit. If you anticipate severe winds, the trampoline should be moved to a sheltered location or completely disassembled. Our anchor kit can be found in the **Accessories** section at www.jumpsport.com.

Diagram 2 JumpSport Trampoline Anchor Kit

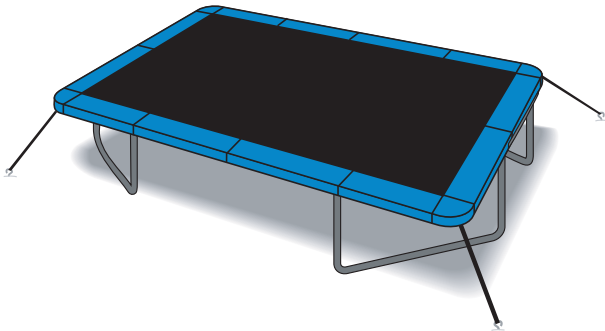

Use a JumpSport Trampoline Anchor Kit to tie down your 10ft x 17ft Staged-Bounce Trampoline.

Moving the Trampoline

If you need to move your trampoline periodically, it should be moved by at least two people, and kept horizontal during the move. Both people should stand next to each other on one of the short ends of the trampoline, and lift that end of the trampoline. Rotate that end of the trampoline about five feet, then go to the opposite end of the trampoline, and do the same thing. This will slowly rotate each end of the trampoline toward your desired destination, and is the easiest way to move the trampoline due to its heavy weight. Disassemble the trampoline for any move greater than a few feet.

Care

Do not allow family pets on the trampoline, as claws may snag and pull the trampoline mat material or damage the frame pad.

The 10ft x 17ft StagedBounce Trampoline is intended to be used by one person at a time, weighing less than 220 pounds. The user should either be barefoot or wearing gymnastic slippers or non-cleated athletic shoes. The user should remove all sharp objects from their person that may cause injury or damage to the trampoline mat. Heavy, sharp, or hard pointed objects should not contact the mat surface.

WARNING



DO NOT attempt or allow somersaults. Landing on the head or neck can cause serious injury, paralysis or death, even when landing in the middle of the bed.



DO NOT allow more than one person on the trampoline. Use by more than one person at the same time can result in serious injury.

Use trampoline only with mature, knowledgeable supervision.

Points of Safety

It is essential that trampoline users follow a carefully planned safety program so that the trampoline can be fully enjoyed. Most accidents can be classified into the following:

- Landing on springs or frame
- Bouncing off the trampoline
- Landing incorrectly on the mat

These are covered in detail in the following sections.

Landing on Springs or Frame

The risk of falling on the springs or frame, landing between the springs, or hitting the frame can be reduced by:

- Proper mounting and dismounting of the trampoline
- Jumping at the center of the mat without traveling toward the side
- Properly installing the frame pads
- Properly installing a JumpSport safety enclosure

Simple frame pads or spring covers on their own do not give adequate protection. Installing the **JumpSport Safety Enclosure** and using spotters, will greatly reduce the risk of injury.

Bouncing off the Trampoline

Bouncing off of the trampoline can be controlled, if not completely eliminated, through:

- Proper instruction and mastering of the “Stop Bounce” technique in the “Basic Skills” section
- Maintaining a position in the center of the mat
- Strictly forbidding any “flying dismounts” (i.e. jumping off of the trampoline onto another object or the ground)
- Installing a **JumpSport Safety Enclosure**
- Using spotters
- Using the trampoline only with mature, knowledgeable supervision

Keep objects away from the trampoline. It is dangerous to jump from the trampoline to the floor or ground. Do not jump from the trampoline into a swimming pool, onto a swing, or any other object. Do not install the trampoline on concrete, asphalt or hard compacted surfaces.

Warning Information

Landing Incorrectly on the Mat

Landing incorrectly on the mat creates great risk of a serious injury, with most injuries resulting from attempted somersaults/flips. It is strongly recommended that somersaults/flips are not performed.

Safety Rules

It is the responsibility of the owner to become familiar with the safety rules and to convey these rules to all users.

WARNING

- DO NOT attempt or allow somersaults. Landing on the head or neck can cause serious injury, paralysis, or death, even when landing in the middle of the bed.
- DO NOT allow more than one person on the trampoline. Use by more than one person at the same time can result in serious injuries.
- Use trampoline only with mature, knowledgeable supervision.
- Trampolines over 20 inches (51 cm) tall are not recommended for use by children under 6 years of age.
- Inspect the trampoline before each use. Make sure the frame padding is correctly and securely positioned. Replace any worn, defective, or missing parts.
- Climb on and off the trampoline. It is a dangerous practice to jump from the trampoline to the floor or ground when dismounting, or to jump onto the trampoline when mounting. Do not use the trampoline as a springboard to other objects.
- Stop bounce by flexing knees as feet come in contact with the trampoline bed. Learn this skill before attempting others.
- Learn fundamental bounces and body positions thoroughly before trying more advanced skills. A variety of trampoline activities can be carried out by performing the basic fundamentals in various series and combinations, performing one fundamental after another, with or without feet bounces between them.
- Avoid bouncing too high. Stay low until bounce control and repeated landing in the center of the trampoline can be accomplished. Control is more important than height.
- While keeping the head erect, focus eyes on the trampoline toward the perimeter. This will help control bounce.
- Avoid bouncing when tired. Keep turns short.
- Properly secure the trampoline when not in use. Protect it against unauthorized use. If a trampoline ladder is used, the supervisor should remove it from the trampoline when leaving the area to prevent unsupervised access by children under 6 years of age.
- Keep objects away which could interfere with the performer. Maintain a clear area around the trampoline.
- Do not use the trampoline while under the influence of alcohol or drugs.
- For additional information concerning the trampoline equipment, contact the manufacturer.
- For information concerning skill training, contact a certified trampoline instructor.
- Bounce only when the surface of the bed is dry. Wind or air movement should be calm to gentle. The trampoline must not be used in gusty or severe winds.
- Read all instructions before using the trampoline. Warnings and instructions for the care, maintenance, and use of this trampoline are included to promote safe, enjoyable use of this equipment.

Note: *The "bed" mentioned above and elsewhere in this manual, refers to the jumping surface (generally referred to as the "mat"). The "frame" mentioned refers to the rail assembly pieces of the trampoline.*

Use Instructions

Basic Skills

Basic trampoline skills include:

- Bouncing
- Stop Bounce
- Arm Action
- Bounce Variations

Bouncing

The most important basic skill in jumping on a trampoline, is controlling the height and landing of your bounce. The goal is to land in the center of the mat, or as close to the center of the mat as possible. The basic bounce should always be low. High, reckless bouncing should never be allowed.

Stop Bounce

The Stop Bounce technique allows the jumper to gain control by stopping quickly. It is done by keeping the feet in contact with the mat, and absorbing the rebound of the trampoline with the knees and waist. This skill should be learned right away and should be employed whenever you feel out of balance, or land away from the center area.

To learn the Stop Bounce:

1. Stand in center of the mat with your feet about hip-width apart.
2. Attempt three easy bounces; keep them low and controlled.
3. Focus your eyes toward the perimeter of the trampoline while bouncing, in order to keep your balance
4. Stop the bounce when your feet contact the mat by bending at your knees and hips.

Arm Action

Arms are very important for proper control and lift. Whenever you go up, your arms go up. They go up to a set position about shoulder height and shoulder width. They should remain in this balanced position until you start to go down. Then they circle down slightly behind the hips, ready to lift again as you bounce up. See Figure 2.

Figure 2 Arm Action

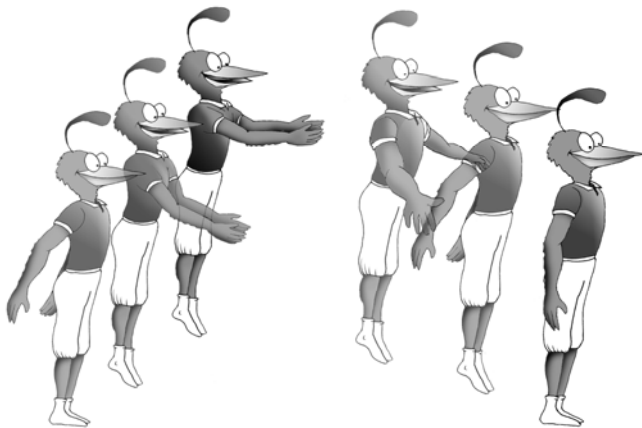

Bounce Variations

Figure 3 shows three variations you can perform in the air. These should be performed at the top of your bounce before returning to the normal landing position on your feet.

Figure 3 Bounce Variations



Tuck



Pike



Straddle

Practice these simple variations and concentrate on perfect form. When you are in position, make sure you point your toes and straighten your fingers (Pike and Straddle variations). Also make sure you take off and land in the same spot on the center of the mat.

These simple variations to the basic bounce can be a lot of fun, and are very important for gaining experience in coordinated movement and balance.

Basic Landing Positions

Once the jumper understands the body placement of the position, the drop can be performed after “priming” the trampoline mat. Priming is done by bending the knees and pushing down on the trampoline mat several times, thereby setting the mat in motion. The feet stay in contact with the mat during the entire priming motion.

Seat Drop

To perform a Seat Drop:

1. From the standing position, prime the mat several times.
2. Pick up your feet at the top of the last bounce, and sit down. You should land with your body in a seated position with your legs straight out in front of you and your toes pointed. Hands should be on the mat next to your hips. Fingers should be together and pointed toward your feet. See Figure 4.
3. Push on the mat with your hands to rebound up to your feet.

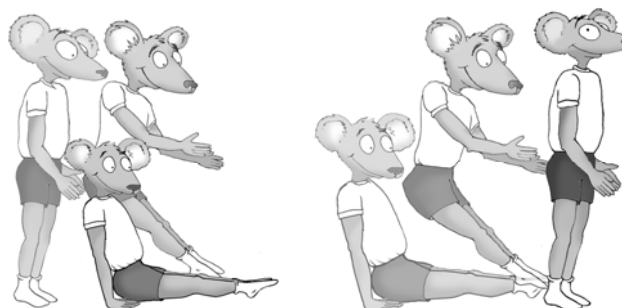

Figure 4 Seat Drop

Use Instructions

Hands and Knees Drop

To do a Hands and Knees Drop properly, there should be just as much weight on the hands as on the knees. The back should be about parallel to the mat. The knees and hands should land simultaneously, with the middle of the body landing in the center of the trampoline. The hands should be directly under the shoulders. The knees should be directly under the hips. The toes should be pointed. See Figure 5.

To perform a Hands and Knees Drop:

1. Get down on your hands and knees on the mat. Make sure you have weight on both your hands and knees. Do not sit on your heels.
2. Remain in this position and try to bounce. Do not rock back and forth between the hands and knees, but develop an even landing on all four points.
3. From the standing position, prime the mat several times. Lift upward with the hips, reach forward with the hands, and land on all fours. Look slightly in front of your hands on landing. Push to rebound to your feet.

Figure 5 Hands and Knees Drop

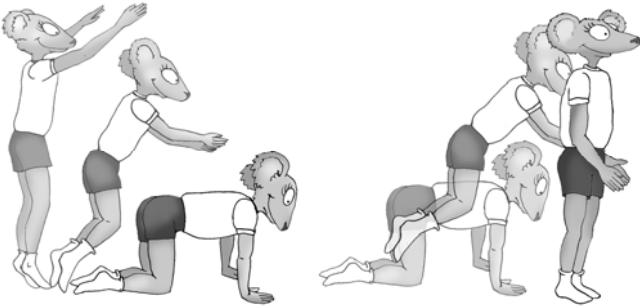

Front Drop

In a front drop, contact with the trampoline mat should simultaneously take place with your hands, elbows, chest, stomach, and hips. Knees should be bent. Hands should be placed close together with palms in contact with the mat, forming a triangle. Eyes should focus on the center of the triangle or slightly in front of your fingers. See Figure 6.

1. First learn how to go from the hands and knees drop to the front drop.
 - a. Start from the hands and knees drop position.
 - b. As you rebound from the hands and knees, stretch so that you land on your stomach. From this position, rebound to your hands and knees.
2. Next, perform Step 1, beginning and ending in a standing crouched position.
 - a. Start from a standing position with your knees bent and your upper body low and close to the trampoline mat.
 - b. Prime the mat several times.
 - c. Lift your hips gently upward and backward.
 - d. Land in a hands and knees drop, rebound and stretch into a front drop, and return to a hands and knees drop.
 - e. Push with the hands to return to your feet.
3. Lastly, perform Step 2 from a standing position.
 - a. Start from a straight standing position.
 - b. Prime the mat several times.
 - c. Perform a Front Drop as in Step 2.

Figure 6 Front Drop

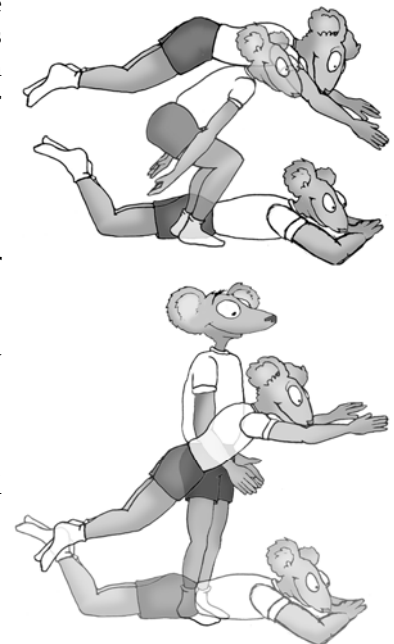

Front Drop Note: *Your body must contact the trampoline mat all at once. If you land on your chest and arms first, they will rebound before the knees hit, which will result in a straining action on the back. If this type of landing is made with a traveling, diving approach, there is a good chance that the elbows may become skinned. If the landing is made so that the knees and hips hit first, then they will rebound and you will land heavily on your shoulders and face.*

Series of Drops

Once you have mastered the individual bounce variations and drops, try performing them in sequence. For example: Seat Drop—Hands and Knees Drop—Front Drop or Seat Drop—Hands and Knees Drop—Seat Drop.

Twisting Moves

Twisting moves include:

- Swivel Hips
- Turntable
- Twist Variations

Swivel Hips

A Swivel Hips is a combination move consisting of a Seat Drop, half twist, then another Seat Drop.

1. First become familiar with the first part of a Swivel Hips.
 - a. Perform a seat drop.
 - b. Push down on the mat with the hands and straighten in the air with your arms stretched over your head.
2. Next, add the half twist.
 - a. Perform Step 1. As you rebound up to your feet, move one shoulder in the direction you want to twist.
 - b. Finish standing with arms stretched overhead, facing the opposite direction (180 degree twist completed).
3. Last, try the complete Swivel Hips twist. See Figure 7.
 - a. Perform a Seat Drop.
 - b. As you rebound with your arms overhead, twist around to face the opposite direction.
 - c. Land in another Seat Drop.

Figure 7 Swivel Hips

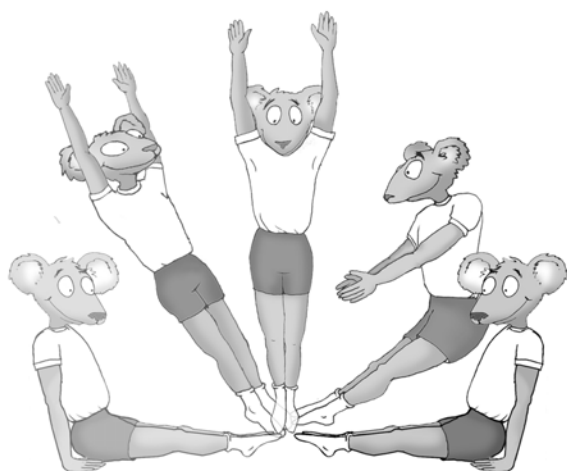

Use Instructions

Turntable

A Turntable is a combination move consisting of a Front Drop, a Half Twist, then another Front Drop.

Figure 8 Turntable

1. First become familiar with the first part of a Turntable.
 - a. Begin in a hands and knees position, with hands forming a triangle, like a Front Drop.
 - b. Prime the mat in this position.
 - c. Push backward with your hands and extend your body to land in the Front Drop position.
 - d. Repeat several times in succession: Hands and Knees Drop—Front Drop—Hands and Knees Drop, etc.
2. Next, perform the movement in Step 1, but at twice the speed so as to bring the knees inward, under the hips and out again without touching the knees on the mat.
3. Now, perform the movement in Step 2, but push sideways on the mat so that your body rotates before you land on the mat.
4. Last, try the complete Turntable twist from a standing position. Prime the mat and perform a Front Drop. Push sideways, complete a 180 degree rotation, and finish in a Front Drop facing the opposite direction. See Figure 8.

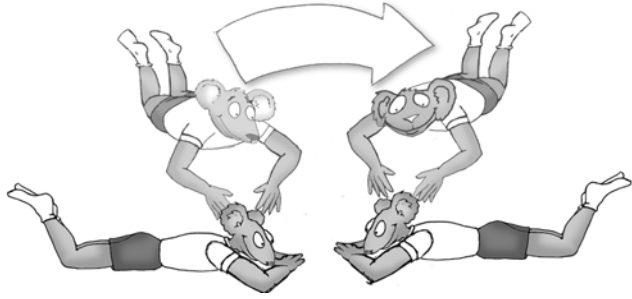

Twist Variations

You can have hours and hours of fun and challenging bouncing by combining twists with each of the basic landing positions (Drops). You can twist after the landing. For example: Seat Drop with a half twist and land on your feet.

You can add more twists. Always remember to practice and perfect the simpler twists before moving on to more complex twists.

You can also perform a series of twists. For example: perform several Swivel Hips in a row, all in the same direction or alternate directions. You can do the same thing with Turntable twisting.

If you find you love the trampoline and have mastered the moves discussed in these instructions, we encourage you to seek additional training from a certified trampoline instructor.

(This page left intentionally blank.)

Use Instructions

(This page left intentionally blank.)

JumpSport®

Limited Warranty

What is covered by this warranty? This warranty covers any defects in materials or workmanship on all of the components of the JumpSport 10ft x 17ft StagedBounce Trampoline, and is extended exclusively to the original retail purchaser.

How long does this coverage last? Warranty coverage for each component begins from the original date of purchase and lasts as follows:

- Steel frame - warranted for 10 years (prorated) as follows:
 - One hundred percent (100%) for the 1st through 5th year
 - Fifty percent (50%) for the 6th year
 - Forty percent (40%) for the 7th year
 - Thirty percent (30%) for the 8th year
 - Twenty percent (20%) for the 9th year
 - Ten percent (10%) during the 10th year
- Fabric on jumping surface (mat) - 5 years
- Stitching on mat (includes V-rings and straps that hold the V-rings in place) - 2 years
- Springs - 2 years
- Frame pad - 6 months

What will JumpSport do? If you return the defective part to JumpSport, as instructed below, JumpSport will either repair or replace such part, at JumpSport's discretion, and return it to you.

What is not covered by this warranty? This warranty does not cover expenses of on-site labor, travel, assembly or disassembly, or other charges associated with the repair or replacement of covered components. This warranty also does not cover any problem that is caused by abuse, misuse, commercial or public use, ordinary wear and tear, weathering, acts of God (such as wind and lightning), failure to follow directions, improper installation, improper maintenance, or any silk screened graphics. Rust is a natural occurrence with any outdoor steel product and is likewise not covered by this warranty, to the extent that it does not affect the structural integrity of the part.

JUMPSPORT IS NOT RESPONSIBLE OR LIABLE FOR INDIRECT, SPECIAL, OR CONSEQUENTIAL DAMAGES ARISING OUT OF OR IN CONNECTION WITH THE USE OR PERFORMANCE OF THE PRODUCT OR OTHER DAMAGES WITH RESPECT TO ANY LOSS, INCLUDING BUT NOT LIMITED TO ECONOMIC LOSS, LOSS OF PROPERTY, LOSS OF REVENUE OR PROFITS, LOSS OF ENJOYMENT OR USE, COST OF REMOVAL, INSTALLATION OR OTHER CONSEQUENTIAL DAMAGES. SOME STATES DO NOT ALLOW THE EXCLUSION OR LIMITATION OF INCIDENTAL OR CONSEQUENTIAL DAMAGES. ACCORDINGLY, THE ABOVE LIMITATION MAY NOT APPLY TO YOU.

THE WARRANTY EXTENDED HEREUNDER IS IN LIEU OF ALL OTHER WARRANTIES AND ANY IMPLIED WARRANTY OF MERCHANTABILITY OR FITNESS FOR A PARTICULAR PURPOSE IS LIMITED IN ITS SCOPE AND DURATION TO THE TERMS SET FORTH HEREIN. SOME STATES DO NOT ALLOW LIMITATIONS ON HOW LONG AN IMPLIED WARRANTY LASTS. ACCORDINGLY, THE ABOVE LIMITATION MAY NOT APPLY TO YOU.

How to get a defective part replaced:

- 1) Call the JumpSport Customer Service department at 408-213-2551 to obtain a Return Authorization number. All returns must be pre-authorized.
- 2) Send the part(s) to the designated Service Center, along with a copy of your original sales receipt and a brief written description of the problem, including how it occurred. You must pay freight and insurance to return the part to JumpSport. At JumpSport's sole discretion, we may ask you to send photographs in addition to or in lieu of returning the part.
- 3) After inspecting the returned part(s), JumpSport will make a final determination whether the part is covered by this warranty. We reserve the right to examine photographs or physical evidence concerning parts claimed to be defective prior to making a final determination concerning the claim. A repaired or replacement part will be returned to you. Please allow 3 to 4 weeks for delivery.

This warranty gives you specific legal rights. You may also have other rights which vary from state to state.

JumpSport, Inc.
2055 South 7th Street, Suite A
San Jose, CA 95112

408-213-2551

<http://www.jumpsport.com>